



TECHNICAL REPORT

Design of Bonded Anchors

TR 029
Edition June 2007

TABLE OF CONTENTS
Design method for bonded anchors

Introduction	4
1 Scope	2
1.1 Type of anchors, anchor groups and number of anchors	2
1.2 Concrete member	3
1.3 Type and direction of load	3
1.4 Safety class	3
2 Terminology and Symbols	4
2.1 Indices	4
2.2 Actions and resistances	4
2.3 Concrete and steel	4
2.4 Characteristic values of anchors (see Figure 2.1)	5
3 Design and safety concept	6
3.1 General	6
3.2 Ultimate limit state	6
3.2.1 Design resistance	6
3.2.2 Partial safety factors for resistances	6
3.2.2.1 Concrete cone failure, splitting failure and pull-out failure, pry-out failure and edge failure	6
3.2.2.2 Steel failure	7
3.3 Serviceability limit state	7
4 Static analysis	7
4.1 Non-cracked and cracked concrete	7
4.2 Loads acting on anchors	8
4.2.1 Tension loads	8
4.2.2 Shear loads	10
4.2.2.1 Distribution of shear loads	10
4.2.2.2 Determination of shear loads	11
4.2.2.3 Shear loads without lever arm	13
4.2.2.4 Shear loads with lever arm	14
5 Ultimate limit state	15
5.1 General	15
5.2 Design method	15
5.2.1 General	15
5.2.2 Resistance to tension loads	15
5.2.2.1 Required proofs	15
5.2.2.2 Steel failure	15
5.2.2.3 Combined pull -out and concrete cone failure	15
5.2.2.4 Concrete cone failure	19
5.2.2.5 Splitting failure due to anchor installation	22
5.2.2.6 Splitting failure due to loading	22
5.2.3 Resistance to shear loads	23
5.2.3.1 Required proofs	23
5.2.3.2 Steel failure	23
5.2.3.3 Concrete pry-out failure	24
5.2.3.4 Concrete edge failure	26
5.2.4 Resistance to combined tension and shear loads	32
6 Serviceability limit state	33
6.1 Displacements	33
6.2 Shear load with changing sign	33
7 Additional proofs for ensuring the characteristic resistance of concrete member	33
7.1 General	33
7.2 Shear resistance of concrete member	34
7.3 Resistance to splitting forces	35

Introduction

The design method for bonded anchors given in the relevant ETA's is based on the experience of a bond resistance for anchors in the range up to 15 N/mm^2 and an intended embedment depth of 8 to 12 anchor diameter. In the meantime anchors are on the market with significant higher bond resistance. Furthermore the advantage of bonded anchors, to be installed with varying embedment, needs a modified design concept. This concept is given in this Technical Report. It covers embedment of min h_{ef} to $20 d$. The minimum embedment depth is given in the ETA, it should be not less than $4d$ and 40mm . Restriction of the embedment depth may be given in the ETA.

Also the assessment and some tests in Part 5 need modifications, because it may be difficult to develop the characteristic bond resistance. Following the concept of Part 5 predominantly steel failure and concrete cone failure may be observed for shallow and deep embedment. These results are of minor interest.

The design method given in this Technical Report is based on Annex C with necessary modifications. It is valid for anchors with European Technical Approval (ETA) according to the new approach with characteristic bond resistance (τ_{Rk}) and it is based on the assumption that the required tests for assessing the admissible service conditions given in Part 1 and Part 5 with modifications according to this Technical Report have been carried out. The use of other design methods will require reconsideration of the necessary tests.

The ETA's for anchors give the characteristic values only of the different approved anchors. The design of the anchorages e.g. arrangement of anchors in a group of anchors, effect of edges or corners of the concrete member on the characteristic resistance shall be carried out according to the design methods described in Chapter 3 to 5 taking account of the corresponding characteristic values of the anchors.

Chapter 7 gives additional proofs for ensuring the characteristic resistance of the concrete.

The design method is valid for all types of bonded anchors except undercut bonded anchors, torque controlled bonded anchors or post installed rebar connections. If values for the characteristic resistance, spacing, edge distances and partial safety factors differ between the design methods and the ETA, the value given in the ETA governs. In the absence of national regulations the partial safety factors given in the following may be used.

1 Scope

1.1 Type of anchors, anchor groups and number of anchors

The design method applies to the design of bonded anchors (according to Part 1 and 5) in concrete using approved anchors which fulfil the requirements of this Guideline. The characteristic values of these anchors are given in the relevant ETA.

The design method is valid for single anchors and anchor groups. In case of an anchor group the loads are applied to the individual anchors of the group by means of a rigid fixture. In an anchor group only anchors of the same type, size and length should be used.

The design method covers single anchors and anchor groups according to Figure 1.1 and 1.2. Other anchor arrangements e.g. in a triangular or circular pattern are also allowed; however, the provisions of this design method should be applied with engineering judgement.

In General this design method is valid only if the diameter d_f of the clearance hole in the fixture is not larger than the value according to Table 4.1.

Exceptions:

- For fastenings loaded in tension only a larger diameter of the clearance hole is acceptable if a correspondent washer is used.
- For fastenings loaded in shear or combined tension and shear if the gap between the hole and the fixture is filled with mortar of sufficient compression strength or eliminated by other suitable means.

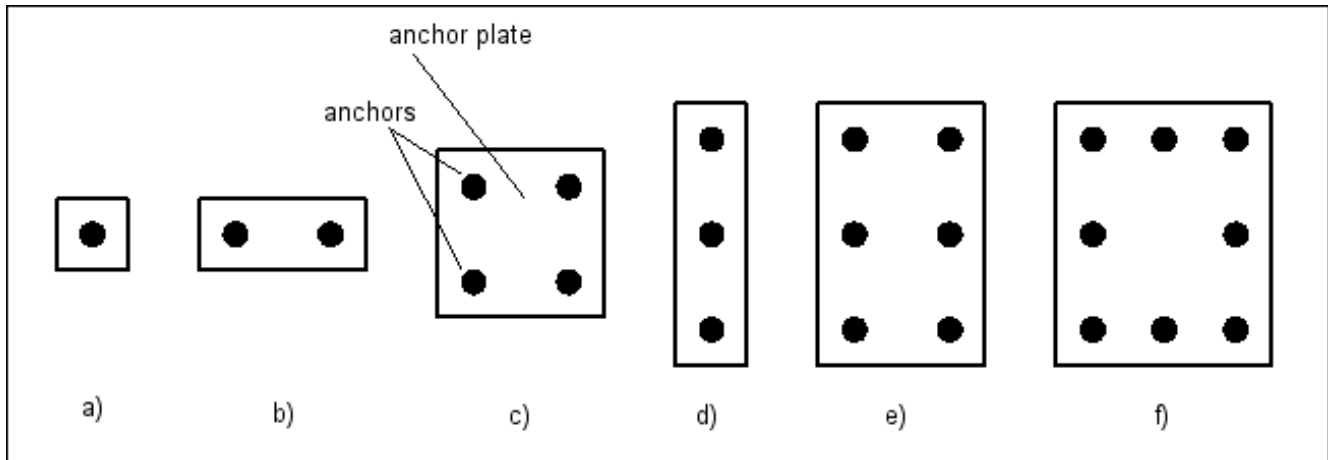

Figure 1.1 Anchorages covered by the design methods

- all loading directions, if anchors are situated far from edges ($c > 10 h_{ef}$ and $> 60 d$)
- tension loading only, if anchors are situated close to edges ($c < 10 h_{ef}$ and $< 60 d$)

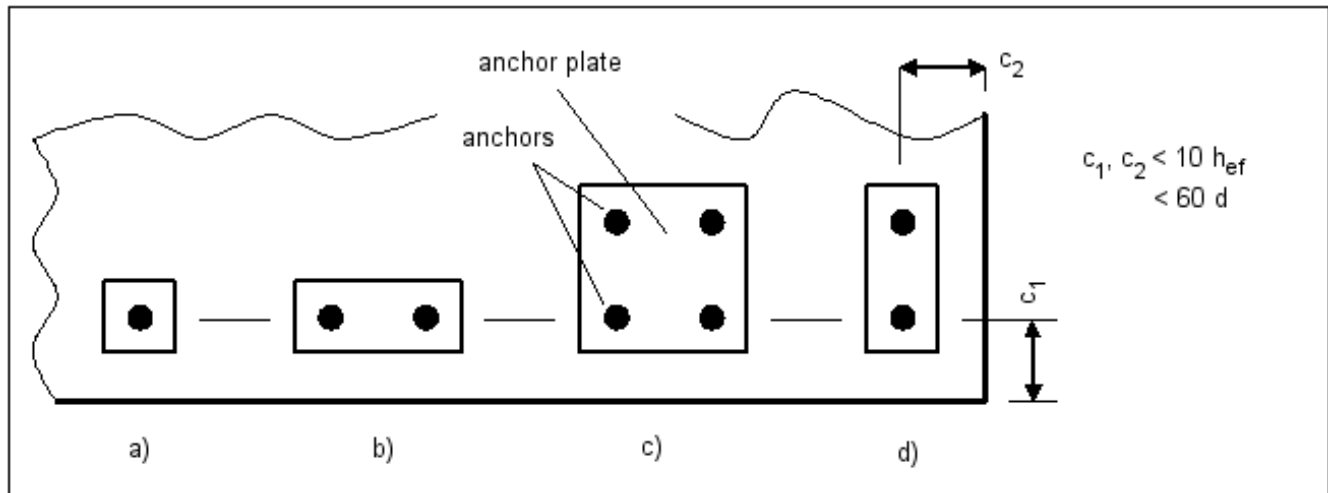

Figure 1.2 Anchorages covered by the design methods

- shear loading, if anchors are situated close to an edge ($c < 10 h_{ef}$ and $< 60 d$)

1.2 Concrete member

The concrete member should be of normal weight concrete of at least strength class C 20/25 and at most strength class C 50/60 to ENV 206 [8] and should be subjected only to predominantly static loads. The concrete may be cracked or non-cracked. In general for simplification it is assumed that the concrete is cracked; otherwise it has to be shown that the concrete is non-cracked (see 4.1).

1.3 Type and direction of load

The design methods apply to anchors subjected to static or quasi-static loadings and not to anchors subjected to impact or seismic loadings.

1.4 Safety class

Anchorage carried out in accordance with these design methods are considered to belong to anchorages, the failure of which would cause risk to human life and/or considerable economic consequences.

2 Terminology and Symbols

The notations and symbols frequently used in the design methods are given below. Further notations are given in the text.

2.1 Indices

S	=	action
R	=	resistance
M	=	material
k	=	characteristic value
d	=	design value
s	=	steel
c	=	concrete
cp	=	concrete pry-out
p	=	pull-out
sp	=	splitting
u	=	ultimate
y	=	yield

2.2 Actions and resistances

F	=	force in general (resulting force)
N	=	normal force (positive: tension force, negative: compression force)
V	=	shear force
M	=	moment
τ	=	bond strength
$F_{Sk} (N_{Sk}; V_{Sk}; M_{Sk}; M_{T,Sk})$	=	characteristic value of actions acting on a single anchor or the fixture of an anchor group respectively (normal load, shear load, bending moment, torsion moment)
$F_{Sd} (N_{Sd}; V_{Sd}; M_{Sd}, M_{T,Sd})$	=	design value of actions
$N_{Sd}^h (V_{Sd}^h)$	=	design value of tensile load (shear load) acting on the most stressed anchor of an anchor group calculated according to 4.2
$N_{Sd}^g (V_{Sd}^g)$	=	design value of the sum (resultant) of the tensile (shear) loads acting on the tensioned (sheared) anchors of a group calculated according to 4.2
$F_{Rk} (N_{Rk}; V_{Rk})$	=	characteristic value of resistance of a single anchor or an anchor group respectively (normal force, shear force)
$F_{Rd} (N_{Rd}; V_{Rd})$	=	design value of resistance

2.3 Concrete and steel

$f_{ck,cube}$	=	characteristic concrete compression strength measured on cubes with a side length of 150 mm (value of concrete strength class according to ENV 206 [8])
f_{yk}	=	characteristic steel yield strength (nominal value)
f_{uk}	=	characteristic steel ultimate tensile strength (nominal value)
A_s	=	stressed cross section of steel
W_{el}	=	elastic section modulus calculated from the stressed cross section of steel ($\frac{\pi d^3}{32}$ for a round section with diameter d)

2.4 Characteristic values of anchors (see Figure 2.1)

a	=	spacing between outer anchors of adjoining groups or between single anchors
a_1	=	spacing between outer anchors of adjoining groups or between single anchors in direction 1
a_2	=	spacing between outer anchors of adjoining groups or between single anchors in direction 2
b	=	width of concrete member
c	=	edge distance
c_1	=	edge distance in direction 1; in case of anchorages close to an edge loaded in shear c_1 is the edge distance in direction of the shear load (see Figure 2.1b and Figure 5.7)
c_2	=	edge distance in direction 2; direction 2 is perpendicular to direction 1
$c_{cr,Np}$	=	edge distance for ensuring the transmission of the characteristic tensile resistance of a single anchor without spacing and edge effects in case of pullout failure
$c_{cr,N}$	=	edge distance for ensuring the transmission of the characteristic tensile resistance of a single anchor without spacing and edge effects in case of concrete cone failure
$c_{cr,sp}$	=	edge distance for ensuring the transmission of the characteristic tensile resistance of a single anchor without spacing and edge effects in case of splitting failure
c_{min}	=	minimum allowable edge distance
d	=	diameter of anchor bolt or thread diameter, in case of internally threaded sockets outside diameter of socket
d_o	=	drill hole diameter
h	=	thickness of concrete member
h_{ef}	=	effective anchorage depth
h_{min}	=	minimum thickness of concrete member
s	=	spacing of anchors in a group
s_1	=	spacing of anchors in a group in direction 1
s_2	=	spacing of anchors in a group in direction 2
$s_{cr,Np}$	=	spacing for ensuring the transmission of the characteristic resistance of a single anchor without spacing and edge effects in case of pullout failure
$s_{cr,N}$	=	spacing for ensuring the transmission of the characteristic tensile resistance of a single anchor without spacing and edge effects in case of concrete cone failure
$s_{cr,sp}$	=	spacing for ensuring the transmission of the characteristic tensile resistance of a single anchor without spacing and edge effects in case of splitting failure
s_{min}	=	minimum allowable spacing

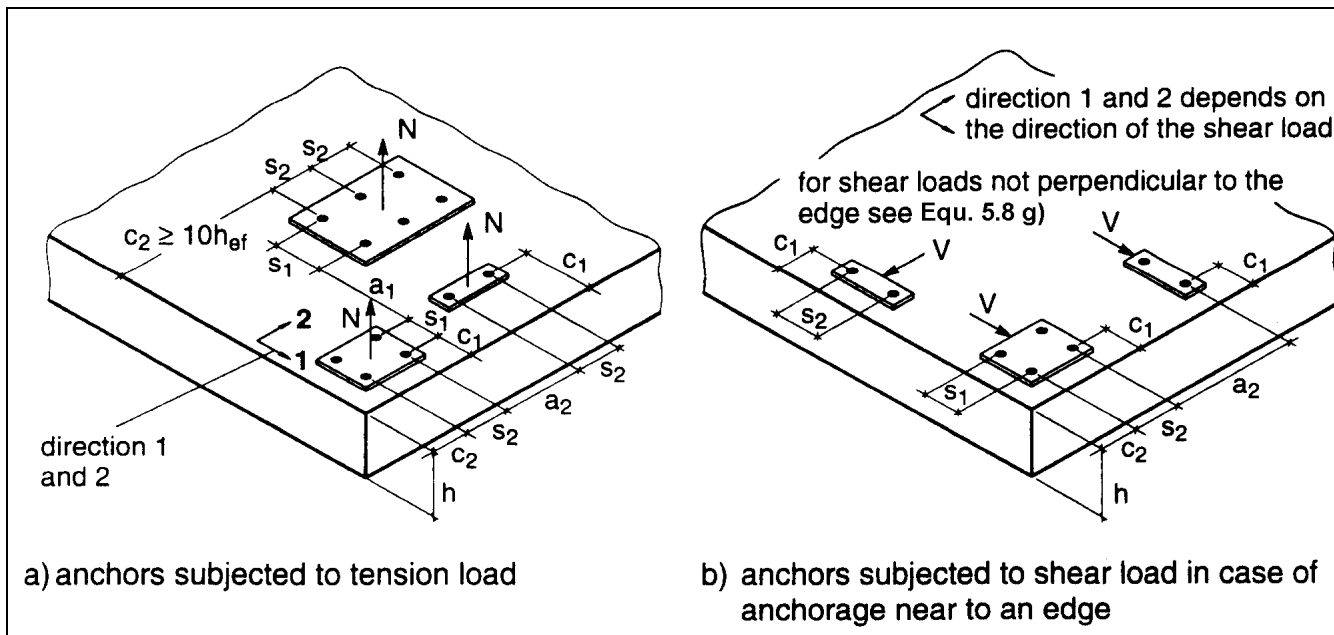

Figure 2.1 Concrete member, anchor spacing and edge distance

3 Design and safety concept

3.1 General

The design of anchorages shall be in accordance with the general rules given in EN 1990. It shall be shown that the value of the design actions S_d does not exceed the value of the design resistance R_d .

$$S_d \leq R_d \tag{3.1}$$

S_d = value of design action
 R_d = value of design resistance

Actions to be used in design may be obtained from national regulations or in the absence of them from the relevant parts of EN 1991.

The partial safety factors for actions may be taken from national regulations or in the absence of them according to EN 1990.

The design resistance is calculated as follows:

$$R_d = R_k / \gamma_M \tag{3.2}$$

R_k = characteristic resistance of a single anchor or an anchor group
 γ_M = partial safety factor for material

3.2 Ultimate limit state

3.2.1 Design resistance

The design resistance is calculated according to Equation (3.2).

3.2.2 Partial safety factors for resistances

In the absence of national regulations the following partial safety factors may be used:

3.2.2.1 Concrete cone failure, splitting failure and pull-out failure, pry-out failure and edge failure

The partial safety factors for concrete cone failure, pry-out failure and edge failure (γ_{Mc}), splitting failure (γ_{Msp}) and pull-out failure (γ_{Mp}) are given in the relevant ETA.

For anchors to according to current experience the partial safety factor γ_{Mc} is determined from:

$$\gamma_{Mc} = \gamma_c \cdot \gamma_2$$

γ_c = partial safety factor for concrete = 1.5
 γ_2 = partial safety factor taking account of the installation safety of an anchor system
The partial safety factor γ_2 is evaluated from the results of the installation safety tests,

see Part 1, 6.1.2.2.2.

Tension loading

$\gamma_2 = 1.0$ for systems with high installation safety
 $= 1.2$ for systems with normal installation safety
 $= 1.4$ for systems with low but still acceptable installation safety

Shear loading

$\gamma_2 = 1.0$

For the partial safety factors γ_{Msp} and γ_{Mp} the value for γ_{Mc} may be taken.

3.2.2.2 Steel failure

The partial safety factors γ_{Ms} for steel failure are given in the relevant ETA.

For anchors according to current experience the partial safety factors γ_{Ms} are determined as a function of the type of loading as follows:

Tension loading:

$$\gamma_{Ms} = \frac{1.2}{f_{yk} / f_{uk}} \geq 1.4 \quad (3.3a)$$

Shear loading of the anchor with and without lever arm:

$$\gamma_{Ms} = \frac{1.0}{f_{yk} / f_{uk}} \geq 1.25 \quad f_{uk} \leq 800 \text{ N/mm}^2 \quad (3.3b)$$

and $f_{yk}/f_{uk} \leq 0.8$

$$\gamma_{Ms} = 1.5 \quad f_{uk} > 800 \text{ N/mm}^2 \quad (3.3c)$$

or $f_{yk}/f_{uk} > 0.8$

3.3 Serviceability limit state

In the serviceability limit state it shall be shown that the displacements occurring under the characteristic actions are not larger than the admissible displacement. For the characteristic displacements see 6. The admissible displacement depends on the application in question and should be evaluated by the designer.

In this check the partial safety factors on actions and on resistances may be assumed to be equal to 1.0.

4 Static analysis

4.1 Non-cracked and cracked concrete

If the condition in Equation (4.1) is not fulfilled or not checked, then cracked concrete is assumed.

Non-cracked concrete may be assumed in special cases if in each case it is proved that under service conditions the anchor with its entire anchorage depth is located in non-cracked concrete. In the absence of other guidance the following provisions may be taken.

For anchorages subjected to a resultant load $F_{Sk} \leq 60$ kN non-cracked concrete may be assumed if Equation (4.1) is observed:

$$\sigma_L + \sigma_R \leq 0 \quad (4.1)$$

$\sigma_L =$ stresses in the concrete induced by external loads, including anchors loads

$\sigma_R =$ stresses in the concrete due to restraint of intrinsic imposed deformations (e.g. shrinkage of concrete) or extrinsic imposed deformations (e.g. due to displacement of support or temperature variations). If no detailed analysis is conducted, then $\sigma_R = 3 \text{ N/mm}^2$ should be assumed, according to EC 2 [1].

The stresses σ_L and σ_R are calculated assuming that the concrete is non-cracked (state I). For plane concrete members which transmit loads in two directions (e.g. slabs, walls) Equation (4.1) should be fulfilled for both directions.

4.2 Loads acting on anchors

In the static analysis the loads and moments are given which are acting on the fixture. To design the anchorage the loads acting on each anchor are calculated, taking into account partial safety factors for actions according to 3.1 in the ultimate limit state and according to 3.3 in the serviceability limit state.

With single anchors normally the loads acting on the anchor are equal to the loads acting on the fixture. With anchor groups the loads, bending and torsion moments acting on the fixture are distributed to tension and shear forces acting on the individual anchors of the group. This distribution shall be calculated according to the theory of elasticity.

4.2.1 Tension loads

In general, the tension loads acting on each anchor due to loads and bending moments acting on the fixture should be calculated according to the theory of elasticity using the following assumptions:

- a) The anchor plate does not deform under the design actions. To ensure the validity of this assumption the anchor plate has to be sufficiently stiff.
- b) The stiffness of all anchors is equal and corresponds to the modulus of elasticity of the steel. The modulus of elasticity of concrete is given in. As a simplification it may be taken as $E_c = 30\,000 \text{ N/mm}^2$.
- c) In the zone of compression under the fixture the anchors do not contribute to the transmission of normal forces (see Figure 4.1b).

If in special cases the anchor plate is not sufficiently stiff, then the flexibility of the anchor plate should be taken into account when calculating loads acting on the anchors.

In the case of anchor groups with different levels of tension forces N_{si} acting on the individual anchors of a group the eccentricity e_N of the tension force N_S^g of the group may be calculated (see Figure 4.1), to enable a more accurate assessment of the anchor group resistance.

If the tensioned anchors do not form a rectangular pattern, for reasons of simplicity the group of tensioned anchors may be resolved into a group rectangular in shape (that means the centre of gravity of the tensioned anchors may be assumed in the centre of the axis in Figure 4.1c)

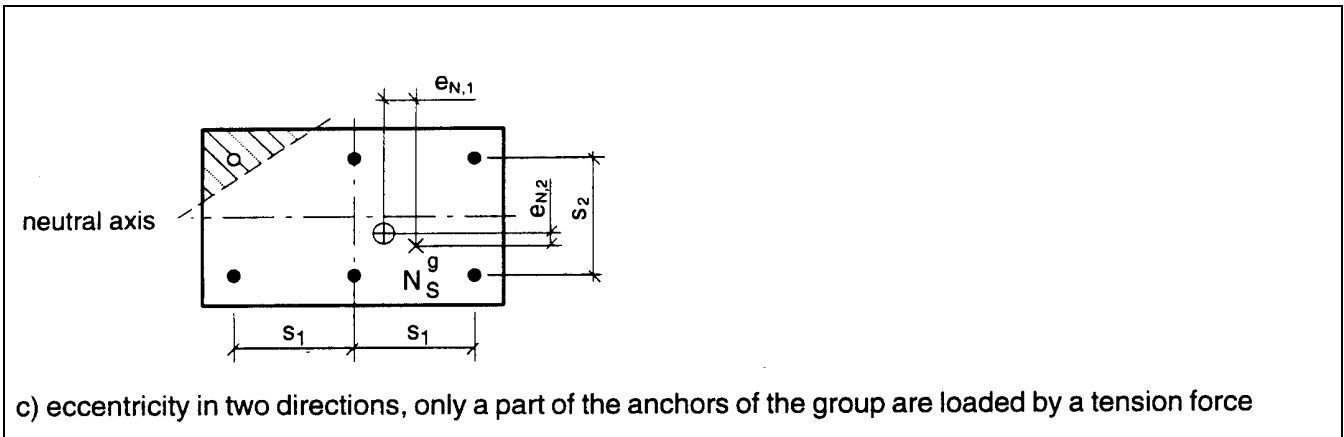
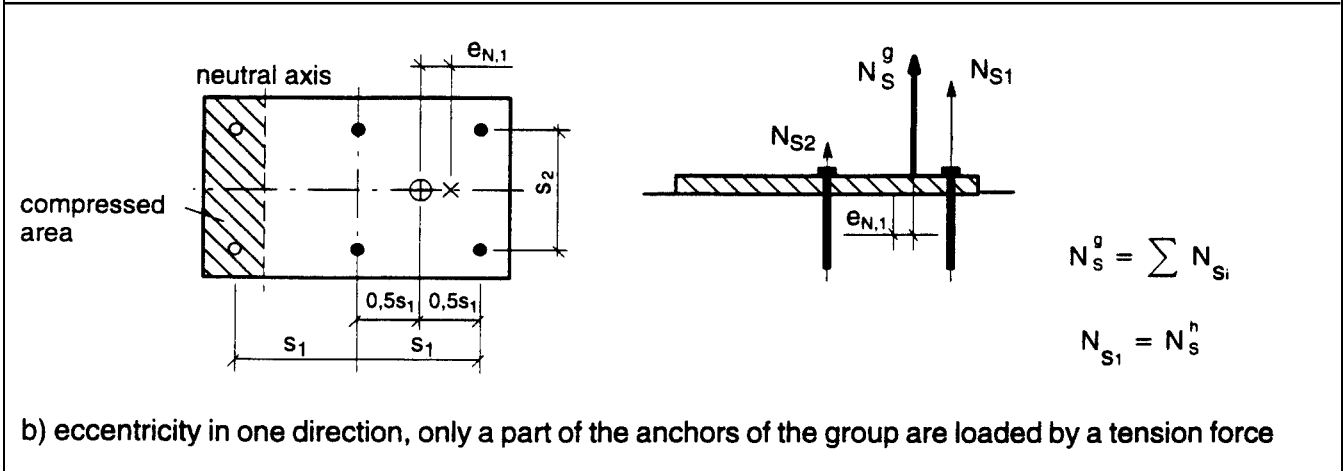
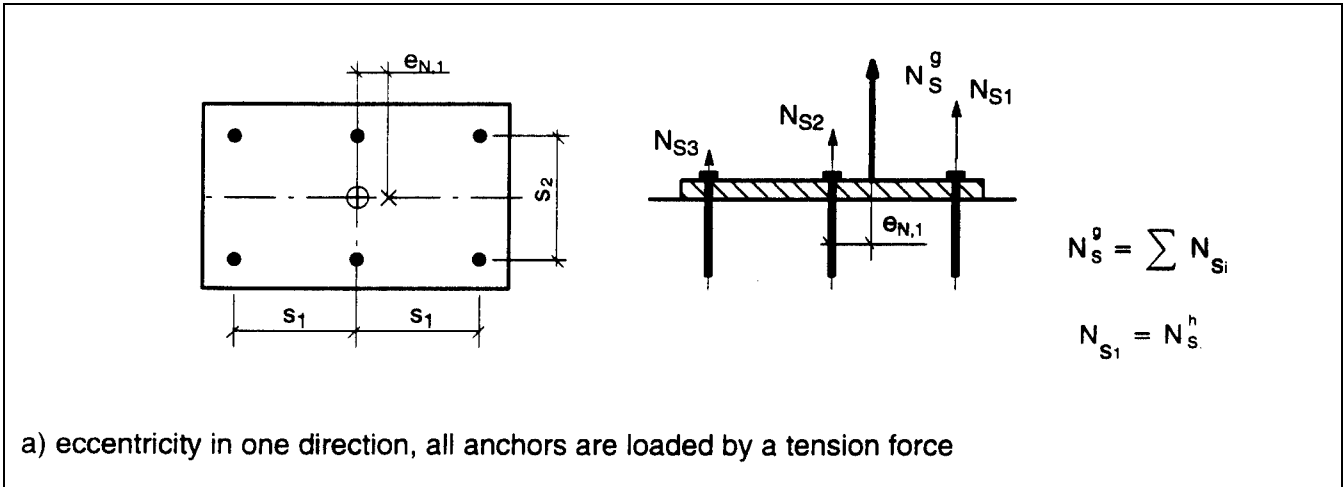

- tensioned anchors
- ⊕ centre of gravity of tensioned anchors
- × point of resulting tensile force of tensioned anchors

Figure 4.1 Example of anchorages subjected to an eccentric tensile load N_S^g

4.2.2 Shear loads

4.2.2.1 Distribution of shear loads

The distribution of shear loads depends on the mode of failure:

a) Steel failure and concrete pry-out failure

It is assumed that all anchors of a group take up shear load if the diameter d_f of clearance hole in the fixture is not larger than the value given in Table 4.1 (see Figure 4.2 and 4.6).

b) Concrete edge failure

Only the most unfavourable anchors take up shear loads if the shear acts perpendicular towards the edge (see Figure 4.3 and 4.7). All anchors take up shear loads acting parallel to the edge.

Slotted holes in direction of the shear load prevent anchors to take up shear loads. This can be favourable in case of fastenings close to an edge (see Figure 4.4).

If the diameter d_f of clearance hole in the fixture is larger than given in Table 4.1 the design method is only valid if the gap between the bolt and the fixture is filled with mortar of sufficient compression strength or eliminated by other suitable means.

Table 4.1 Diameter of clearance hole in the fixture

external diameter $d^{1)} \text{ or } d_{nom}^{2)}$ (mm)	6	8	10	12	14	16	18	20	22	24	27	30
diameter d_f of clearance hole in the fixture (mm)	7	9	12	14	16	18	20	22	24	26	30	33
¹⁾ if bolt bears against the fixture ²⁾ if sleeve bears against the fixture												

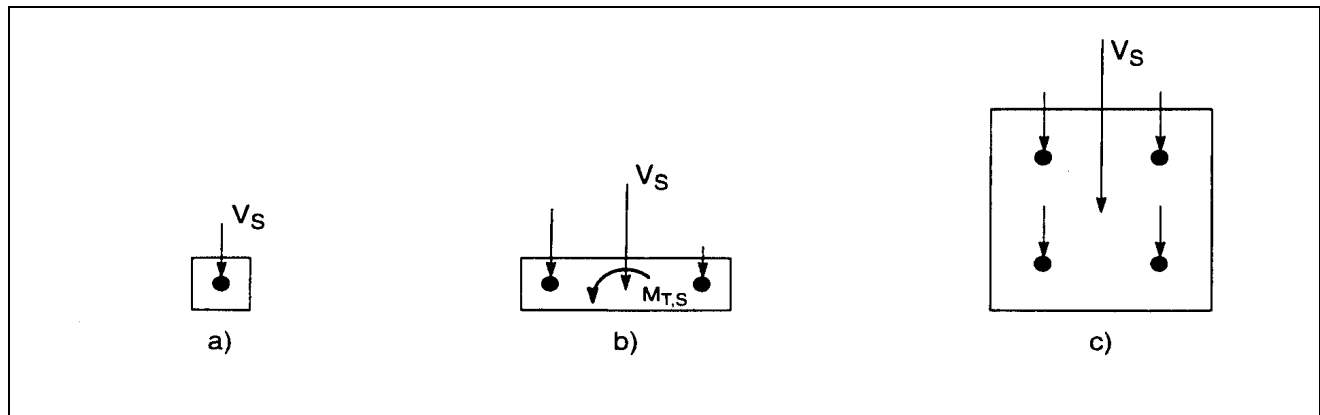

Figure 4.2 Examples of load distribution, when all anchors take up shear loads

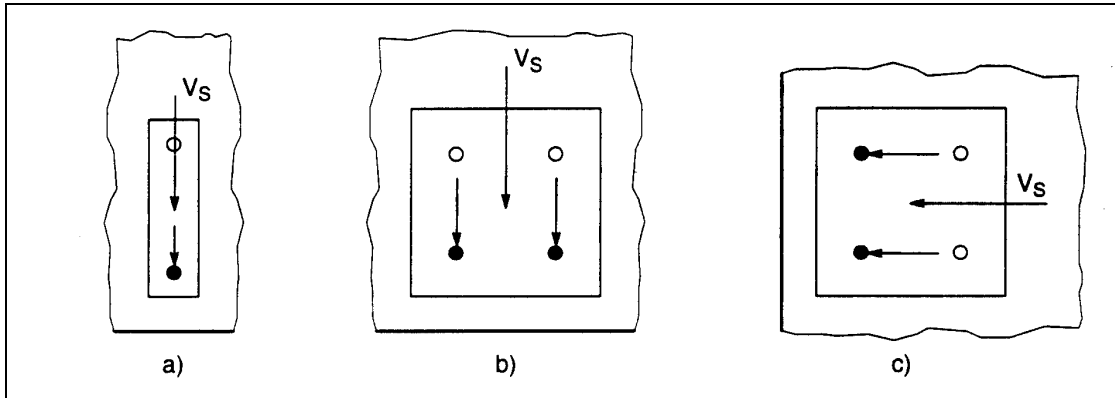

Figure 4.3 Examples of load distribution, when only the most unfavourable anchors take up shear loads

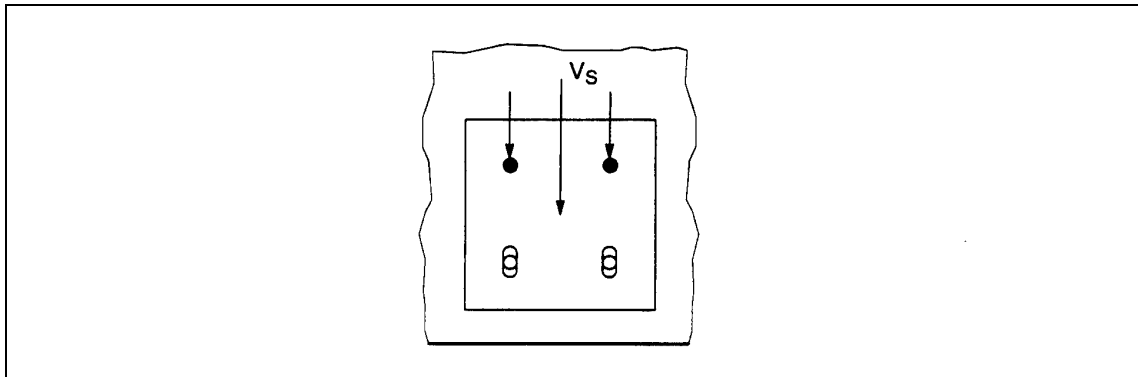

Figure 4.4 Examples of load distribution for a fastening with slotted holes

In the case of anchor groups with different levels of shear forces V_{si} acting on the individual anchors of the group the eccentricity e_v of the shear force V_s^g of the group may be calculated (see Figure 4.5), to enable a more accurate assessment of the anchor group resistance.

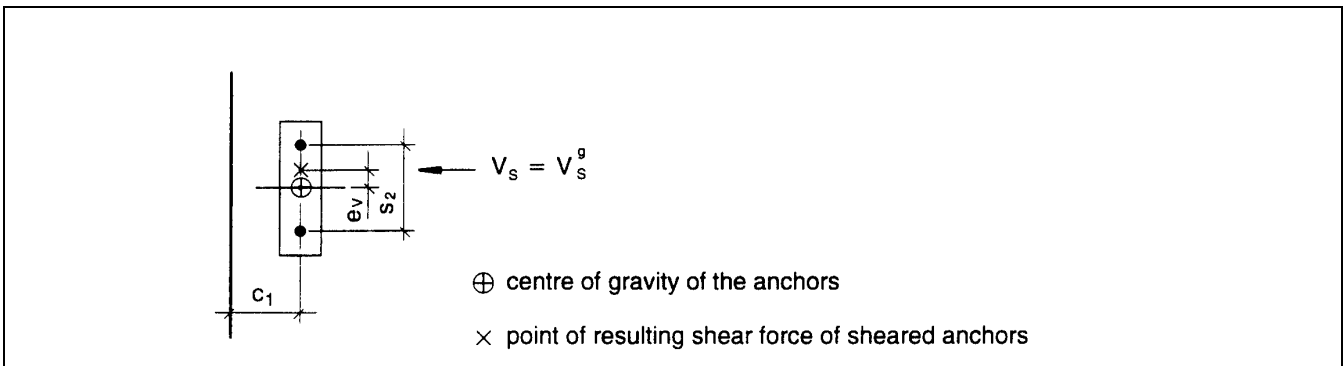

Figure 4.5 Example for a fastening subjected to an eccentric shear load

4.2.2.2 Determination of shear loads

The determination of shear loads to the fasteners in a group resulting from shear forces and torsion moments acting on the fixture is calculated according to the theory of elasticity assuming equal stiffness for all fasteners of a group. Equilibrium has to be satisfied. Examples are given in Figs 4.6 and 4.7.

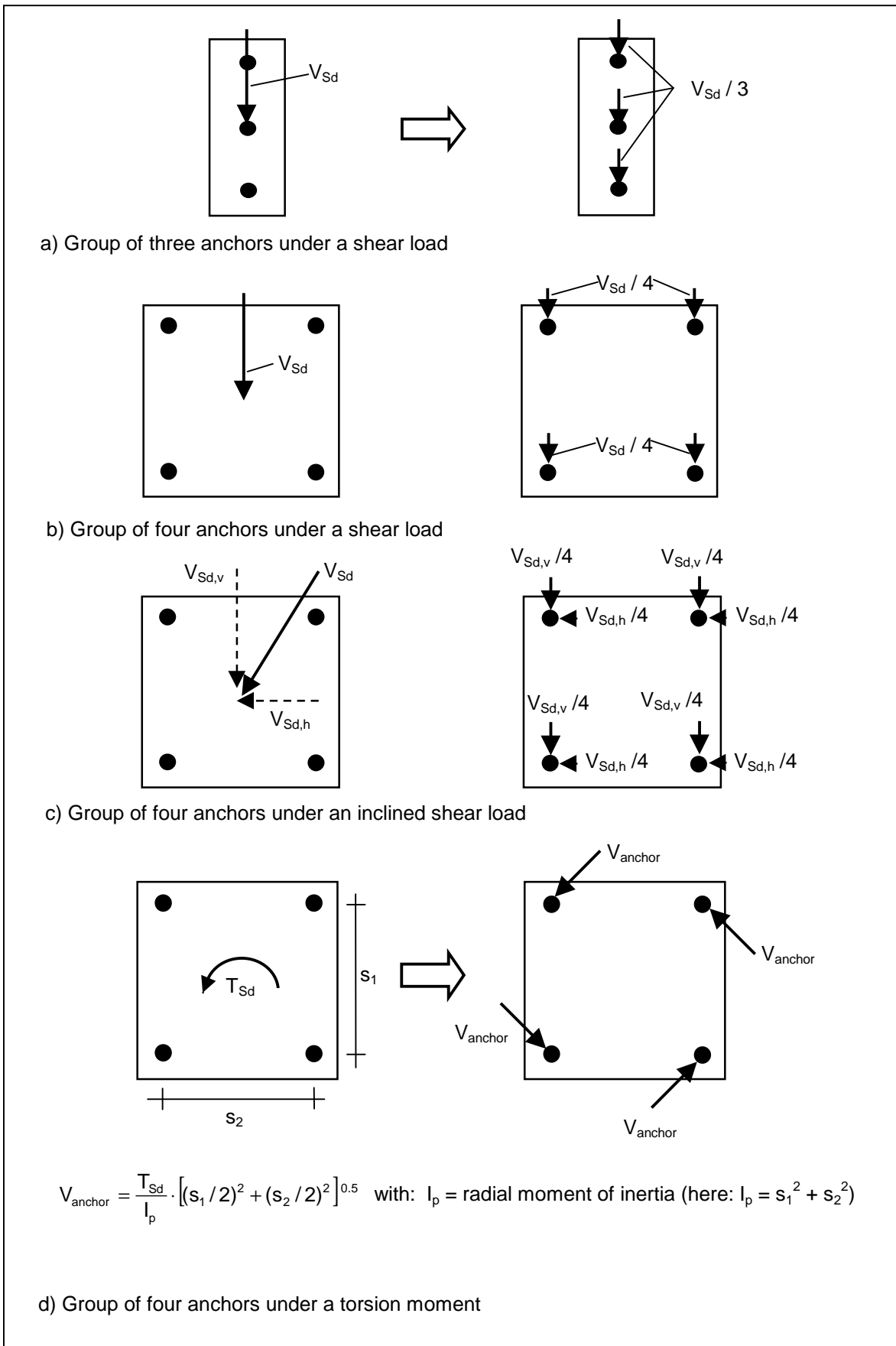

Figure 4.6 Determination of shear loads when all anchors take up loads (steel and pry-out failure)

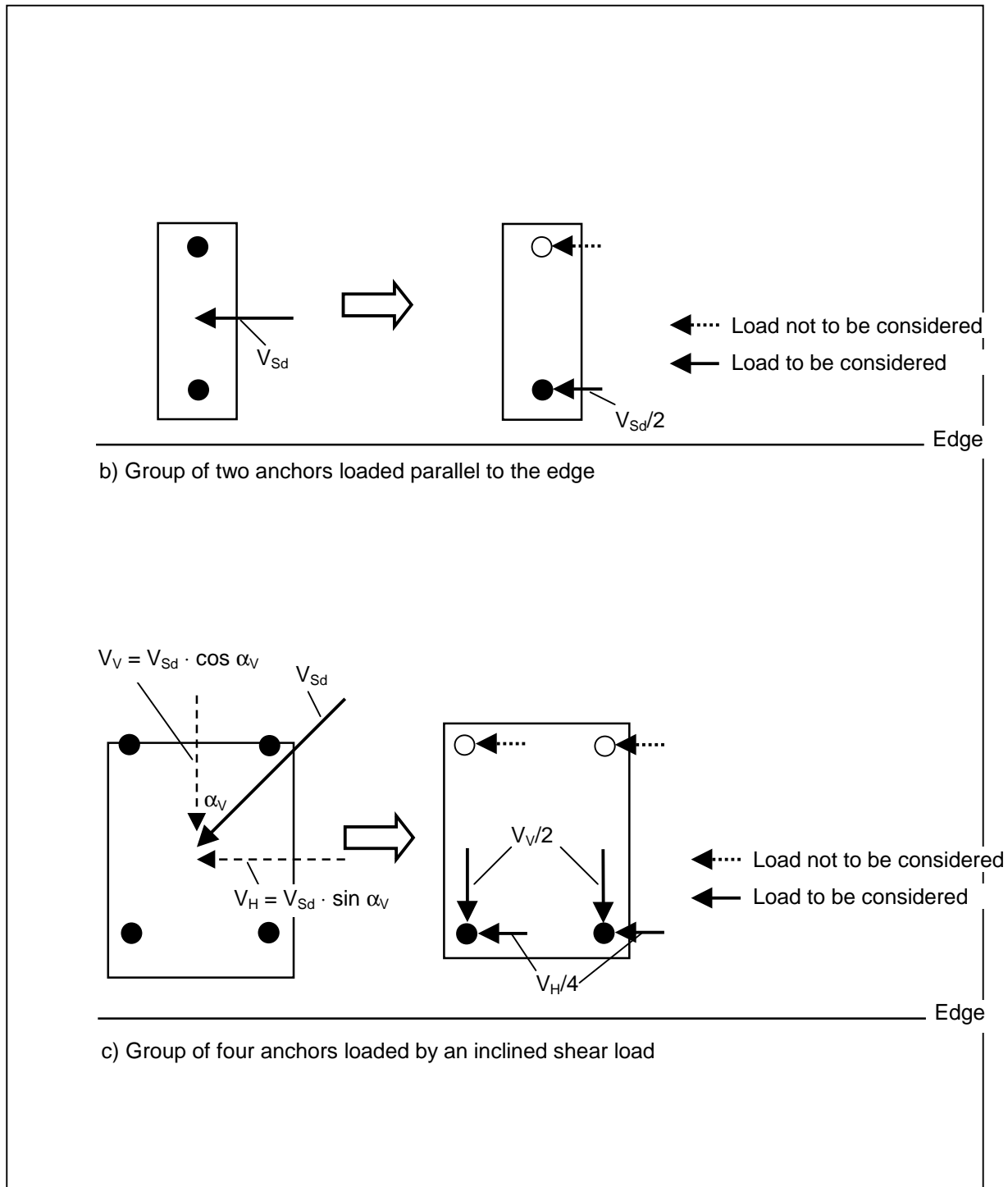

Figure 4.7 Determination of shear loads when only the most unfavourable anchors take up loads (concrete edge failure)

In case of concrete edge failure where only the most unfavourable anchors take up load the component of the load acting perpendicular to the edge are taken up by the most unfavourable anchors (anchors close to the edge), while the components of the load acting parallel to the edge are – due to reasons of equilibrium – equally distributed to all anchors of the group.

4.2.2.3 Shear loads without lever arm

Shear loads acting on anchors may be assumed to act without lever arm if both of the following conditions are fulfilled:

- The fixture shall be made of metal and in the area of the anchorage be fixed directly to the concrete either without an intermediate layer or with a levelling layer of mortar (compression strength $\geq 30 \text{ N/mm}^2$) with a thickness $\leq d/2$.
- The fixture shall be in contact with the anchor over its entire thickness.

4.2.2.4 Shear loads with lever arm

If the conditions a) and b) of 4.2.2.3 are not fulfilled the lever arm is calculated according to Equation (4.2) (see Figure 4.8)

$$l = a_3 + e_1 \quad (4.2)$$

with

e_1 = distance between shear load and concrete surface

$a_3 = 0.5 d$

$a_3 = 0$ if a washer and a nut is directly clamped to the concrete surface (see Figure 4.8b)

d = nominal diameter of the anchor bolt or thread diameter (see Figure 4.8a)

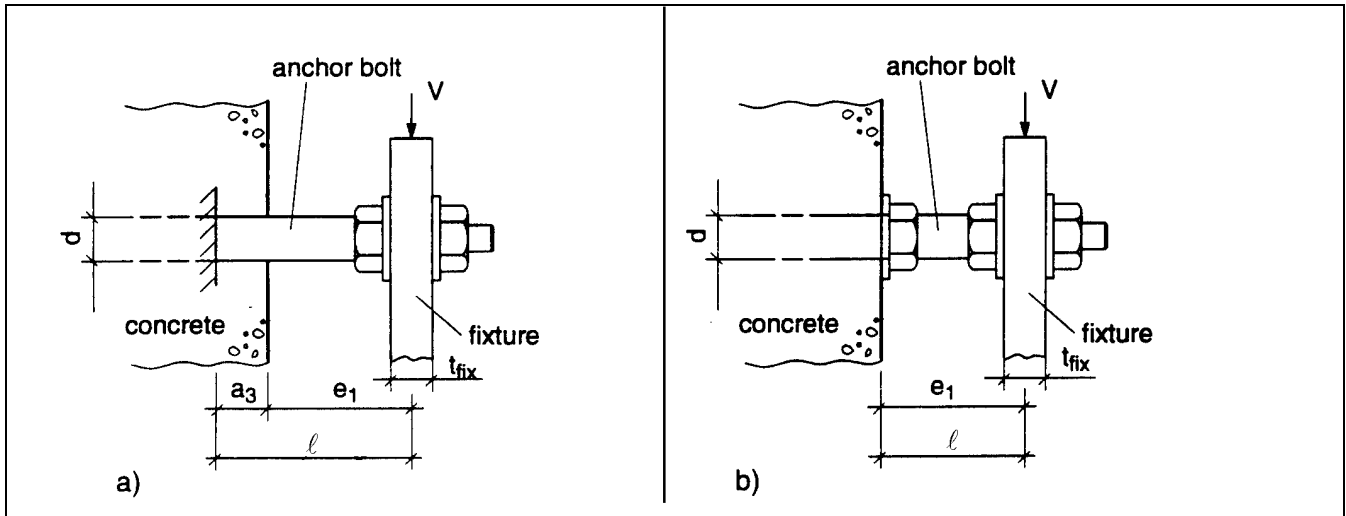

Figure 4.8 Definition of lever arm

The design moment acting on the anchor is calculated according to Equation (4.3)

$$M_{Sd} = V_{Sd} \cdot \frac{l}{\alpha_M} \quad (4.3)$$

The value α_M depends on the degree of restraint of the anchor at the side of the fixture of the application in question and shall be judged according to good engineering practice.

No restraint ($\alpha_M = 1.0$) shall be assumed if the fixture can rotate freely (see Figure 4.9a). This assumption is always on the safe side.

Full restraint ($\alpha_M = 2.0$) may be assumed only if the fixture cannot rotate (see Figure 4.9b) and the hole clearance in the fixture is smaller than the values given in Table 4.1 or the anchor is clamped to the fixture by nut and washer (see Figure 4.8). If restraint of the anchor is assumed the fixture shall be able to take up the restraint moment.

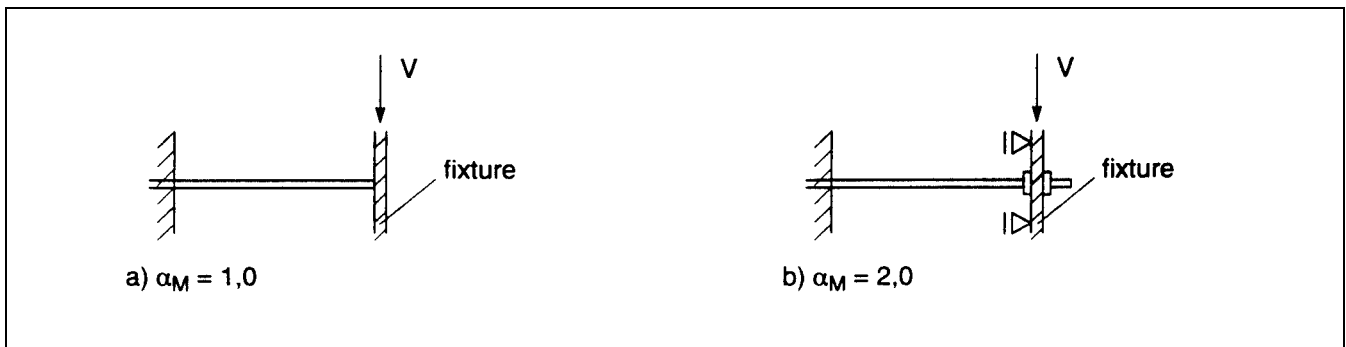

Figure 4.9 Fixture without (a) and with (b) restraint

5 Ultimate limit state

5.1 General

According to Equation (3.1) it has to be shown that the design value of the action is equal to or smaller than the design value of the resistance. The characteristic values of the anchor to be used for the calculation of the resistance in the ultimate limit state are given in the relevant ETA.

Spacing, edge distance as well as thickness of concrete member should not remain under the given minimum values.

The spacing between outer anchor of adjoining groups or the distance to single anchors should be $a > s_{cr,N}$.

5.2 Design method

5.2.1 General

It has to be shown that Equation (3.1) is observed for all loading directions (tension, shear) as well as all failure modes (steel failure, combined pull-out and concrete cone failure, concrete cone failure, splitting failure, concrete edge failure and concrete pry-out failure).

In case of a combined tension and shear loading (oblique loading) the condition of interaction according to 5.2.4 should be observed.

5.2.2 Resistance to tension loads

5.2.2.1 Required proofs

	single anchor	anchor group	
steel failure	$N_{Sd} \leq N_{Rk,s} / \gamma_{Ms}$	$N_{Sd}^h \leq N_{Rk,s} / \gamma_{Ms}$	
combined pull-out and concrete cone failure	$N_{Sd} \leq N_{Rk,p} / \gamma_{Mp}$		$N_{Sd}^g \leq N_{Rk,p} / \gamma_{Mp}$
concrete cone failure	$N_{Sd} \leq N_{Rk,c} / \gamma_{Mc}$		$N_{Sd}^g \leq N_{Rk,c} / \gamma_{Mc}$
splitting failure	$N_{Sd} \leq N_{Rk,sp} / \gamma_{Msp}$		$N_{Sd}^g \leq N_{Rk,sp} / \gamma_{Msp}$

5.2.2.2 Steel failure

The characteristic resistance of an anchor in case of steel failure, $N_{Rk,s}$, is

$$N_{Rk,s} = A_s \cdot f_{uk} \quad [N] \quad (5.1)$$

$N_{Rk,s}$ is given in the relevant ETA.

5.2.2.3 Combined pull -out and concrete cone failure

The characteristic resistance in case of combined pull -out and concrete cone failure, $N_{Rk,p}$, is

$$N_{Rk,p} = N_{Rk,p}^0 \cdot \frac{A_{p,N}}{A_{p,N}^0} \cdot \Psi_{s,Np} \cdot \Psi_{g,Np} \cdot \Psi_{ec,Np} \cdot \Psi_{re,Np} \quad [N] \quad (5.2)$$

The different factors of Equation (5.2) for anchors according to current experience are given below:

a) The initial value of the characteristic resistance of an anchor is obtained by:

$$N_{Rk,p}^0 = \pi \cdot d \cdot h_{ef} \cdot \tau_{Rk} \quad [N] \quad (5.2a)$$

$$\tau_{Rk} \quad [N/mm^2]; h_{ef} \text{ and } d \quad [mm]$$

τ_{Rk} characteristic bond resistance, depending on the concrete strength class, values given for applications in cracked concrete ($\tau_{Rk,cr}$) or for applications in non-cracked concrete ($\tau_{Rk,ucr}$) in the relevant ETA

- b) The geometric effect of spacing and edge distance on the characteristic resistance is taken into account by the value $A_{p,N} / A_{p,N}^0$, where:

$$\begin{aligned}
 A_{p,N}^0 &= \text{influence area of an individual anchor with large spacing and edge distance at the concrete surface, idealizing the concrete cone as a pyramid with a base length equal to } s_{cr,Np} \text{ (see Figure 5.1).} \\
 &= s_{cr,Np} \cdot s_{cr,Np} & (5.2b) \\
 A_{p,N} &= \text{actual area; it is limited by overlapping areas of adjoining anchors (} s \leq s_{cr,Np} \text{) as well as by edges of the concrete member (} c \leq c_{cr,Np} \text{). Examples for the calculation of } A_{p,N} \text{ are given in Figure 5.2.}
 \end{aligned}$$

with

$$s_{cr,Np} = 20 \cdot d \cdot \left(\frac{\tau_{Rk,ucr}}{7.5} \right)^{0.5} \leq 3 \cdot h_{ef} \quad [\text{mm}] \quad (5.2c)$$

with $\tau_{Rk,ucr}$ for C20/25 [N/mm²]; d [mm]

$$c_{cr,Np} = \frac{s_{cr,Np}}{2} \quad [\text{mm}] \quad (5.2d)$$

Note: The values according to Equations (5.2c) and (5.2d) are valid for both cracked and non-cracked concrete.

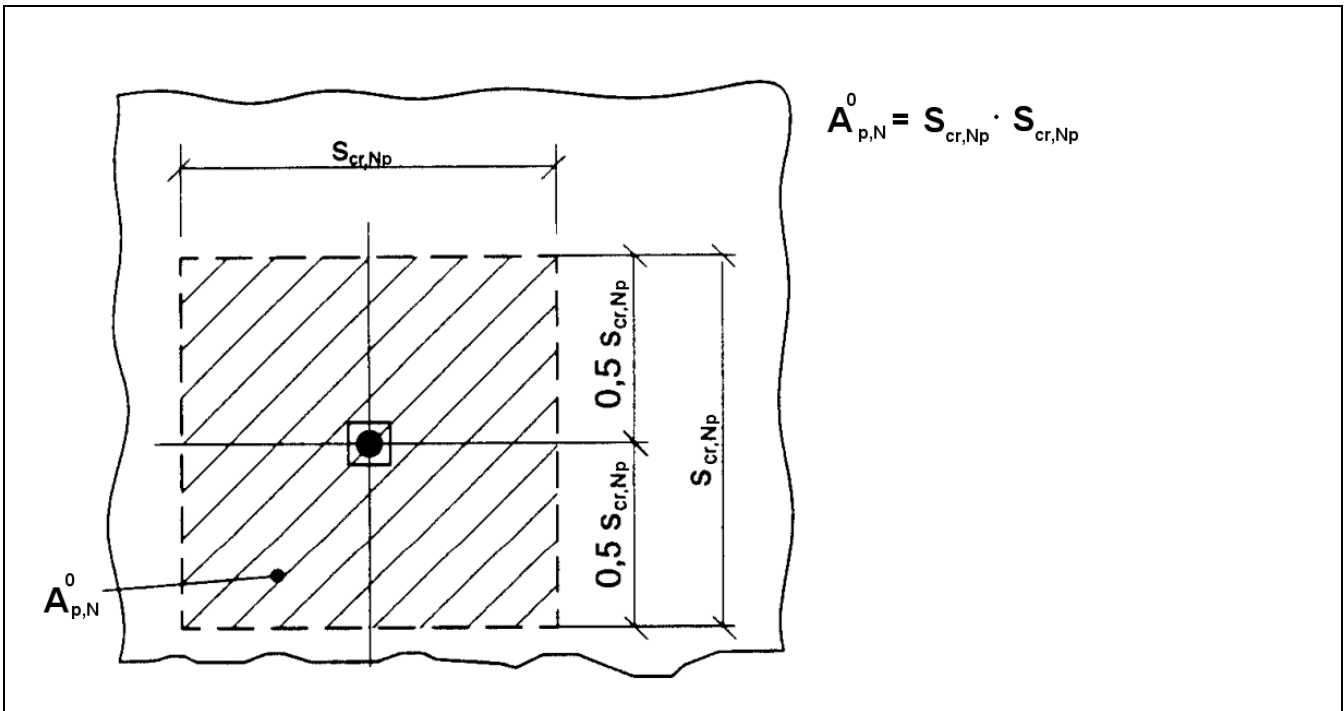

Figure 5.1 Influence area $A_{p,N}^0$ of an individual anchor

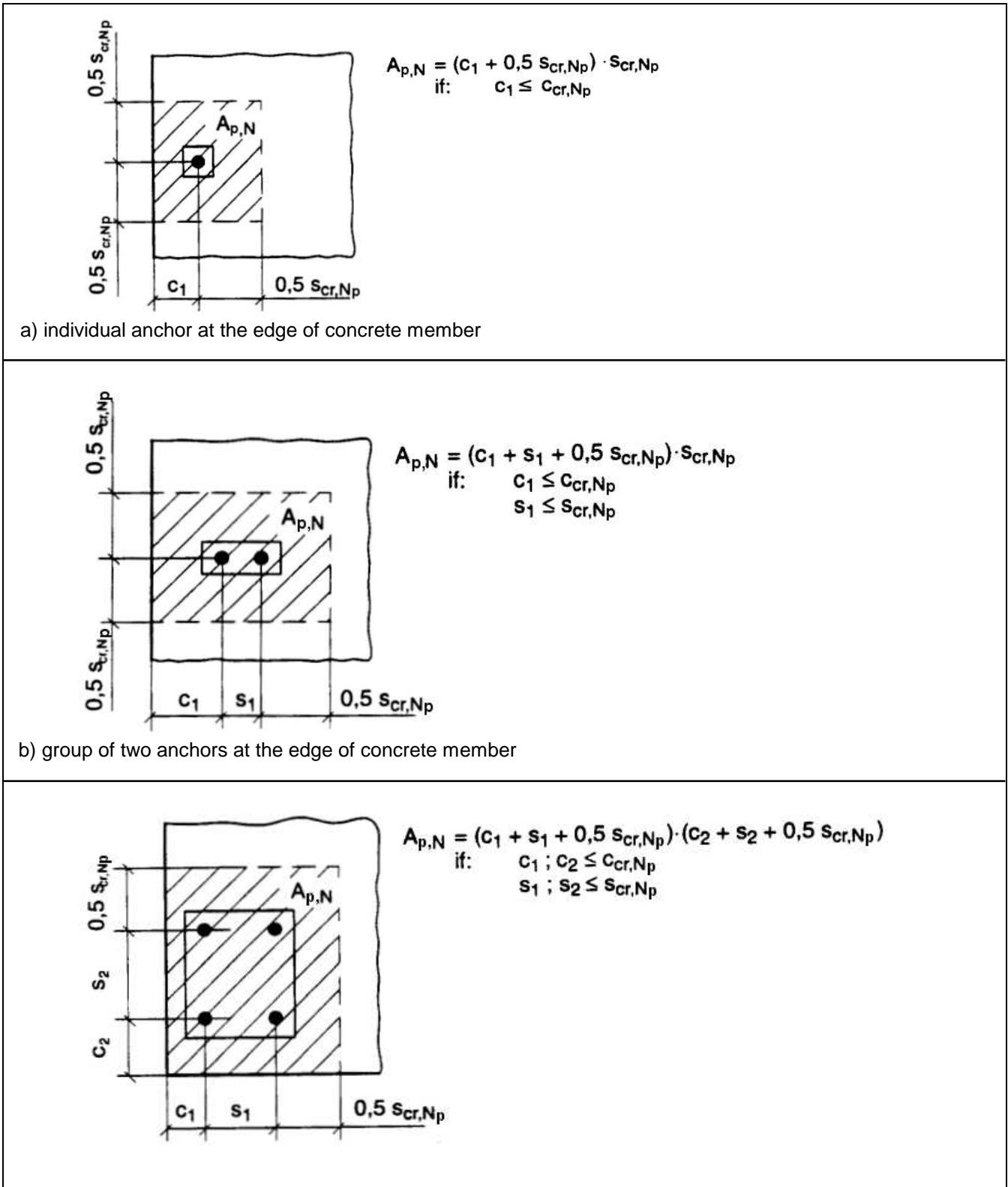

Figure 5.2 Examples of actual areas $A_{p,N}$ for different arrangements of anchors in the case of axial tension load

- c) The factor $\psi_{s,Np}$ takes account of the disturbance of the distribution of stresses in the concrete due to edges of the concrete member. For anchorages with several edge distances (e.g. anchorage in a corner of the concrete member or in a narrow member), the smallest edge distance, c , shall be inserted in Equation (5.2e).

$$\psi_{s,Np} = 0.7 + 0.3 \cdot \frac{c}{c_{cr,Np}} \leq 1 \quad (5.2e)$$

d) The factor, $\psi_{g,Np}$, takes account of the effect of the failure surface for anchor groups

$$\psi_{g,Np} = \psi_{g,Np}^0 - \left(\frac{s}{s_{cr,Np}} \right)^{0,5} \cdot (\psi_{g,Np}^0 - 1) \geq 1,0 \quad (5.2f)$$

s = spacing, in case of anchor groups with $s_1 \neq s_2$ the mean value of all spacings s_1 and s_2 should be taken

with

$$\psi_{g,Np}^0 = \sqrt{n} - (\sqrt{n} - 1) \cdot \left(\frac{d \cdot \tau_{Rk}}{k \cdot \sqrt{h_{ef}} \cdot f_{ck,cube}} \right)^{1,5} \geq 1,0 \quad (5.2g)$$

n = number of anchors in a group

τ_{Rk} and $f_{ck,cube}$ [N/mm²]; h_{ef} and d [mm]

τ_{Rk} characteristic bond resistance, depending on the concrete strength class is taken from the relevant ETA:

k = 2.3 (for applications in cracked concrete)

k = 3.2 (for applications in non-cracked concrete)

e) The factor of $\psi_{ec,Np}$ takes account of a group effect when different tension loads are acting on the individual anchors of a group.

$$\psi_{ec,Np} = \frac{1}{1 + 2e_N/s_{cr,Np}} \leq 1 \quad (5.2h)$$

e_N = eccentricity of the resulting tensile load acting on the tensioned anchors (see 4.2.1). Where there is an eccentricity in two directions, $\psi_{ec,N}$ shall be determined separately for each direction and the product of both factors shall be inserted in Equation (5.2).

f) The shell spalling factor, $\psi_{re,Np}$, takes account of the effect of a dense reinforcement

$$\psi_{re,Np} = 0.5 + \frac{h_{ef}}{200} \leq 1 \quad (5.2i)$$

h_{ef} [mm]

If in the area of the anchorage there is a reinforcement with a spacing ≥ 150 mm (any diameter) or with a diameter ≤ 10 mm and a spacing ≥ 100 mm then a shell spalling factor of $\psi_{re,Np} = 1.0$ may be applied independently of the anchorage depth.

g) *Special cases*

For anchorages with three or more edges with an edge distance $c_{max} \leq c_{cr,Np}$ (c_{max} = largest edge distance) (see Figure 5.3) the calculation according to Equation 5.2 leads to results which are on the safe side.

More precise results are obtained if for h_{ef} the larger value of

$$h'_{ef} = \frac{c_{max}}{c_{cr,Np}} \cdot h_{ef} \quad \text{or} \quad h'_{ef} = \frac{s_{max}}{s_{cr,Np}} \cdot h_{ef}$$

is inserted in Equation (5.2a) and (5.2i) and for the determination of $A_{c,N}^0$ and $A_{c,N}$ according to Figures 5.1 and 5.2 as well as in Equations (5.2b) to (5.2h) the values

$$s'_{cr,Np} = \frac{c_{max}}{c_{cr,Np}} \cdot s_{cr,Np}$$

$$c'_{cr,Np} = 0.5 \cdot s'_{cr,Np}$$

are inserted for $s_{cr,Np}$ or $c_{cr,Np}$, respectively.

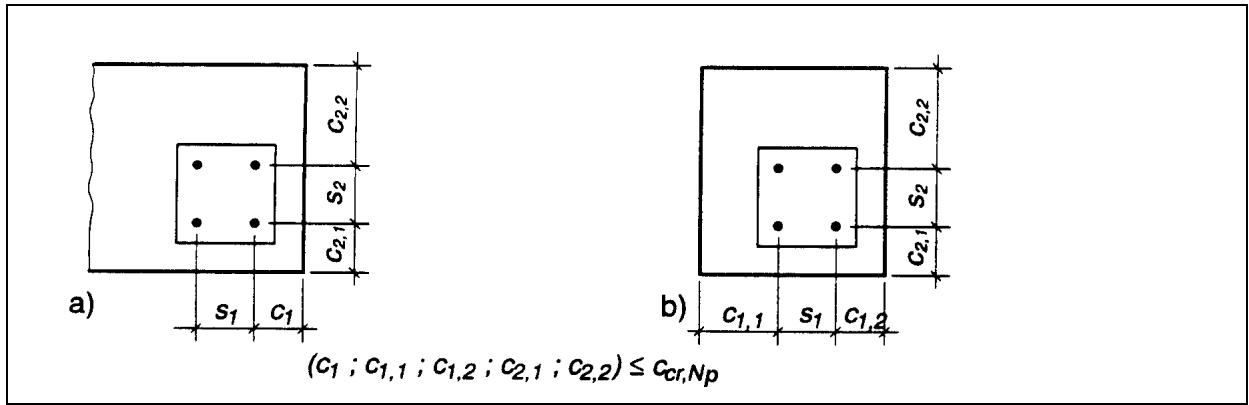

Figure 5.3 Examples of anchorages in concrete members where h'_{ef} , $S'_{cr,Np}$ and $C'_{cr,Np}$ may be used

5.2.2.4 Concrete cone failure

The characteristic resistance of an anchor or a group of anchors, respectively, in case of concrete cone failure is:

$$N_{Rk,c} = N_{Rk,c}^0 \cdot \frac{A_{c,N}}{A_{c,N}^0} \cdot \Psi_{s,N} \cdot \Psi_{re,N} \cdot \Psi_{ec,N} \cdot [N] \quad (5.3)$$

The different factors of Equation (5.3) for anchors according to current experience are given below:

- a) The initial value of the characteristic resistance of an anchor placed in cracked or non-cracked concrete is obtained by:

$$N_{Rk,c}^0 = k_1 \cdot \sqrt{f_{ck,cube}} \cdot h_{ef}^{1.5} \quad [N] \quad (5.3a)$$

$f_{ck,cube}$ [N/mm²]; h_{ef} [mm]

$k_1 = 7.2$ for applications in cracked concrete

$k_1 = 10.1$ for applications in non-cracked concrete

- b) The geometric effect of spacing and edge distance on the characteristic resistance is taken into account by the value $A_{c,N}/A_{c,N}^0$, where:

$A_{c,N}^0$ = area of concrete of an individual anchor with large spacing and edge distance at the concrete surface, idealizing the concrete cone as a pyramid with a height equal to h_{ef} and a base length equal to $s_{cr,N}$ (see Figure 5.4a).

$$= s_{cr,N} \cdot s_{cr,N} \quad \text{with } s_{cr,N} = 3 h_{ef} \quad (5.3b)$$

$A_{c,N}$ = actual area of concrete cone of the anchorage at the concrete surface. It is limited by overlapping concrete cones of adjoining anchors ($s \leq s_{cr,N}$) as well as by edges of the concrete member ($c \leq c_{cr,N}$). Examples for the calculation of $A_{c,N}$ are given in Figure 5.4b.

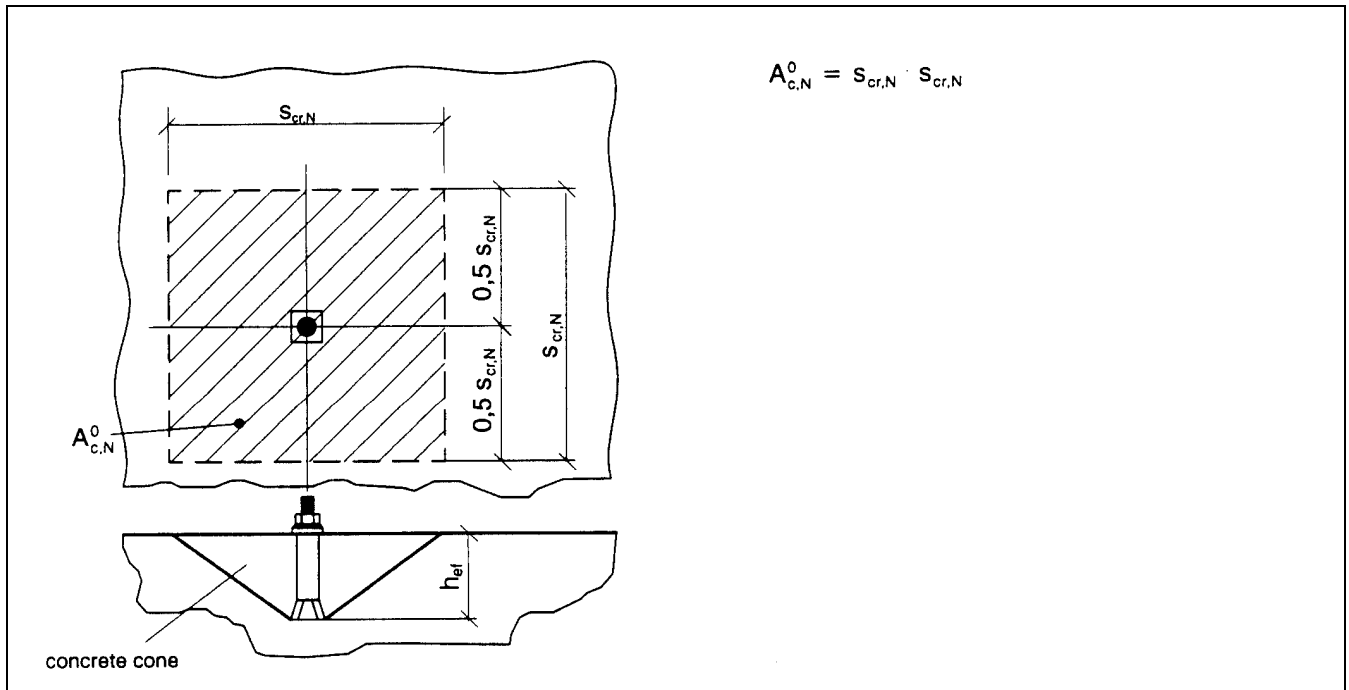
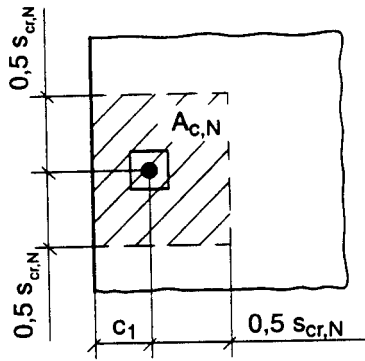

Figure 5.4a Idealized concrete cone and area $A_{c,N}^0$ of concrete cone of an individual anchor



$$A_{c,N} = (c_1 + 0,5 s_{cr,N}) \cdot s_{cr,N}$$

if: $c_1 \leq c_{cr,N}$

a) individual anchor at the edge of concrete member

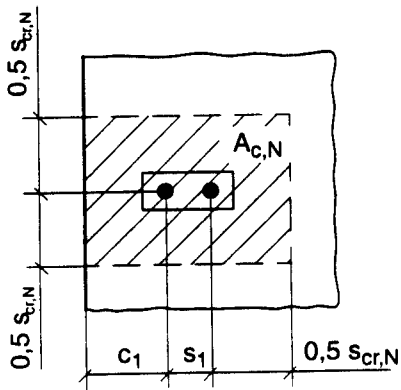

$$A_{c,N} = (c_1 + s_1 + 0,5 s_{cr,N}) \cdot s_{cr,N}$$

if: $c_1 \leq c_{cr,N}$
 $s_1 \leq s_{cr,N}$

b) group of two anchors at the edge of concrete member

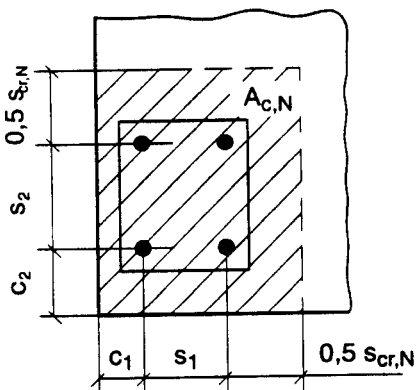

$$A_{c,N} = (c_1 + s_1 + 0,5 s_{cr,N}) \cdot (c_2 + s_2 + 0,5 s_{cr,N})$$

if: $c_1 ; c_2 \leq c_{cr,N}$
 $s_1 ; s_2 \leq s_{cr,N}$

c) group of four anchors at a corner of concrete member

Figure 5.4b Examples of actual areas $A_{c,N}$ of the idealized concrete cones for different arrangements of anchors in the case of axial tension load

- c) The factor $\psi_{s,N}$ takes account of the disturbance of the distribution of stresses in the concrete due to edges of the concrete member. For anchorages with several edge distances (e.g. anchorage in a corner of the concrete member or in a narrow member), the smallest edge distance, c , shall be inserted in Equation (5.3c).

$$\psi_{s,N} = 0.7 + 0.3 \cdot \frac{c}{c_{cr,N}} \leq 1 \quad (5.3c)$$

- d) The shell spalling factor, $\psi_{re,N}$, takes account of the effect of a reinforcement

$$\psi_{re,N} = 0.5 + \frac{h_{ef}}{200} \leq 1 \quad (5.3d)$$

h_{ef} [mm]

If in the area of the anchorage there is a reinforcement with a spacing ≥ 150 mm (any diameter) or with a diameter ≤ 10 mm and a spacing ≥ 100 mm then a shell spalling factor of $\psi_{re,N} = 1.0$ may be applied independently of the anchorage depth.

- e) The factor of $\psi_{ec,N}$ takes account of a group effect when different tension loads are acting on the individual anchors of a group.

$$\psi_{ec,N} = \frac{1}{1 + 2e_N / s_{cr,N}} \leq 1 \quad (5.3e)$$

e_N = eccentricity of the resulting tensile load acting on the tensioned anchors (see 4.2.1). Where there is an eccentricity in two directions, $\psi_{ec,N}$ shall be determined separately for each direction and the product of both factors shall be inserted in Equation (5.3).

- f) *Special cases*

For anchorages with three or more edges with an edge distance $c_{max} \leq c_{cr,N}$ (c_{max} = largest edge distance) (see Figure 5.3) the calculation according to Equation 5.3 leads to results which are on the safe side.

More precise results are obtained if for h_{ef} the larger value of

$$h'_{ef} = \frac{c_{max}}{c_{cr,N}} \cdot h_{ef} \quad \text{or} \quad h'_{ef} = \frac{s_{max}}{s_{cr,N}} \cdot h_{ef}$$

is inserted in Equation (5.3a) and (5.3d) and for the determination of $A_{c,N}^0$ and $A_{c,N}$ according to Figures 5.3 and 5.4 as well as in Equations (5.3b), (5.3c) and (5.3e) the values

$$s'_{cr,N} = 3 h'_{ef}$$

$$c'_{cr,N} = 0,5 s'_{cr,N}$$

are inserted for $s_{cr,N}$ or $c_{cr,N}$, respectively.

5.2.2.5 Splitting failure due to anchor installation

Splitting failure is avoided during anchor installation by complying with minimum values for edge distance c_{min} , spacing s_{min} , member thickness h_{min} and reinforcement as given in the relevant ETA.

5.2.2.6 Splitting failure due to loading

For splitting failure due to loading the values $c_{cr,sp}$ and $s_{cr,sp}$ shall be taken from the ETA as a function of the embedment depth.

- a) It may be assumed that splitting failure will not occur, if the edge distance in all directions is $c \geq 1.2 c_{cr,sp}$ and the member depth is $h \geq 2 h_{min}$.
- b) With anchors suitable for use in cracked concrete, the calculation of the characteristic splitting resistance may be omitted if the following two conditions are fulfilled:
- a reinforcement is present which limits the crack width to $w_k \sim 0.3$ mm, taking into account the splitting forces according to 7.3
 - the characteristic resistance for concrete cone failure and pull-out failure is calculated for cracked concrete.

If the conditions a) or b) are not fulfilled, then the characteristic resistance of a single anchor or an anchor group in case of splitting failure should be calculated according to Equation (5.4)

$$N_{Rk,sp} = N_{Rk,c}^0 \cdot \frac{A_{c,N}}{A_{c,N}^0} \cdot \psi_{s,N} \cdot \psi_{re,N} \cdot \psi_{ec,N} \cdot \psi_{h,sp} \quad [N] \quad (5.4)$$

with $N_{Rk,c}^0$, $\psi_{s,N}$, $\psi_{re,N}$, $\psi_{ec,N}$ according to Equations (5.3a) to (5.3e) and $A_{c,N}$, $A_{c,N}^0$ as defined in 5.2.2.4 b), however the values $c_{cr,N}$ and $s_{cr,N}$ should be replaced by $c_{cr,sp}$ and $s_{cr,sp}$.

$\psi_{h,sp}$ = factor to account for the influence of the actual member depth, h , on the splitting resistance for anchors according to current experience

$$= \left(\frac{h}{h_{min}} \right)^{2/3} \quad (5.4a)$$

with

$$1 \leq \psi_{h,sp} \leq \left(\frac{2 \cdot h_{ef}}{h_{min}} \right)^{2/3} \quad (5.4b).$$

If the edge distance of an anchor is smaller than the value $c_{cr,sp}$ then a longitudinal reinforcement should be provided along the edge of the member.

5.2.3 Resistance to shear loads

5.2.3.1 Required proofs

	single anchor	anchor group	
steel failure, shear load without lever arm	$V_{Sd} \leq V_{Rk,s} / \gamma_{Ms}$	$V_{Sd}^h \leq V_{Rk,s} / \gamma_{Ms}$	
steel failure, shear load with lever arm	$V_{Sd} \leq V_{Rk,s} / \gamma_{Ms}$	$V_{Sd}^h \leq V_{Rk,s} / \gamma_{Ms}$	
concrete pry-out failure	$V_{Sd} \leq V_{Rk,cp} / \gamma_{Mc}$		$V_{Sd}^g \leq V_{Rk,cp} / \gamma_{Mc}$
concrete edge failure			$V_{Sd}^g \leq V_{Rk,c} / \gamma_{Mc}$

5.2.3.2 Steel failure

a) Shear load without lever arm

The characteristic resistance of an anchor in case of steel failure, $V_{Rk,s}$ is taken from the relevant ETA. In case of current experience it is given by Equation (5.5).

$$V_{Rk,s} = 0.5 \cdot A_s \cdot f_{uk} \quad [N] \quad (5.5)$$

$V_{Rk,s}$ is given in the relevant ETA.

In case of anchor groups, the characteristic shear resistance given in the relevant ETA is multiplied with a factor 0.8, if the anchor is made of steel with a rather low ductility (rupture elongation $A_5 \leq 8\%$)

b) Shear load with lever arm

The characteristic resistance of an anchor, $V_{Rk,s}$, is given by Equation (5.6).

$$V_{Rk,s} = \frac{\alpha_M \cdot M_{Rk,s}}{\ell} \quad [N] \quad (5.6)$$

where α_M = see 4.2.2.4

ℓ = lever arm according to Equation (4.2)

$$M_{Rk,s} = M_{Rk,s}^0 (1 - N_{Sd}/N_{Rd,s}) \quad [Nm] \quad (5.6a)$$

$N_{Rd,s}$ = $N_{Rk,s} / \gamma_{Ms}$

$N_{Rk,s}$, γ_{Ms} to be taken from the relevant ETA

$M_{Rk,s}^0$ = characteristic bending resistance of an individual anchor

The characteristic bending resistance $M_{Rk,s}^0$ shall be taken from the relevant ETA.

The value of $M_{Rk,s}^0$ for anchors according to current experience is obtained from Equation (5.6b).

$$M_{Rk,s}^0 = 1.2 \cdot W_{el} \cdot f_{uk} \quad [Nm] \quad (5.6b)$$

5.2.3.3 Concrete pry-out failure

Anchorage with short stiff anchors can fail by a concrete pry-out failure at the side opposite to load direction (see Figure 5.5). The corresponding characteristic resistance $V_{Rk,cp}$ may be calculated from Equation (5.7) and (5.7a); the lowest value of (5.7) and (5.7a) is decisive.

$$V_{Rk,cp} = k \cdot N_{Rk,p} \quad (5.7)$$

$$V_{Rk,cp} = k \cdot N_{Rk,c} \quad (5.7a)$$

where k = factor to be taken from the relevant ETA

$N_{Rk,p}$ and $N_{Rk,c}$ according to 5.2.2.3 and 5.2.2.4 determined for single anchors or all anchors of a group loaded in shear.

For anchors according to current experience failing under tension load by concrete cone failure the following values are on the safe side

$$k = 1 \quad h_{ef} < 60mm \quad (5.7b)$$

$$k = 2 \quad h_{ef} \geq 60mm \quad (5.7c)$$

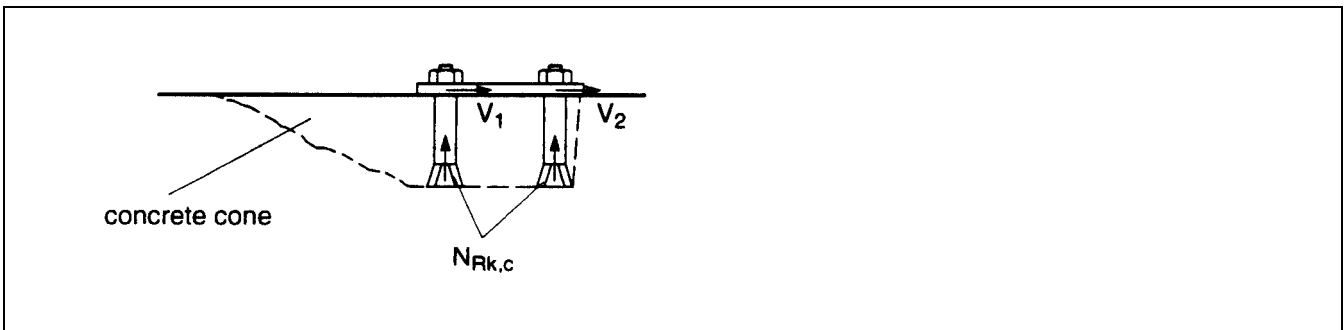

Figure 5.5 Concrete pry-out failure on the side opposite to load direction
Verification of pry-out failure for the most unfavourable anchor

In cases where the group is loaded by shear loads and/or external torsion moments, the direction of the individual shear loads may alter. Fig. 5.5a demonstrates this for a group of two anchors loaded by a torsion moment.

It is self-explanatory that Equation (5.7) and (5.7a) are not suitable for this application. The shear loads acting on the individual anchors neutralise each other and the shear load acting on the entire group is $V_{Sd} = 0$.

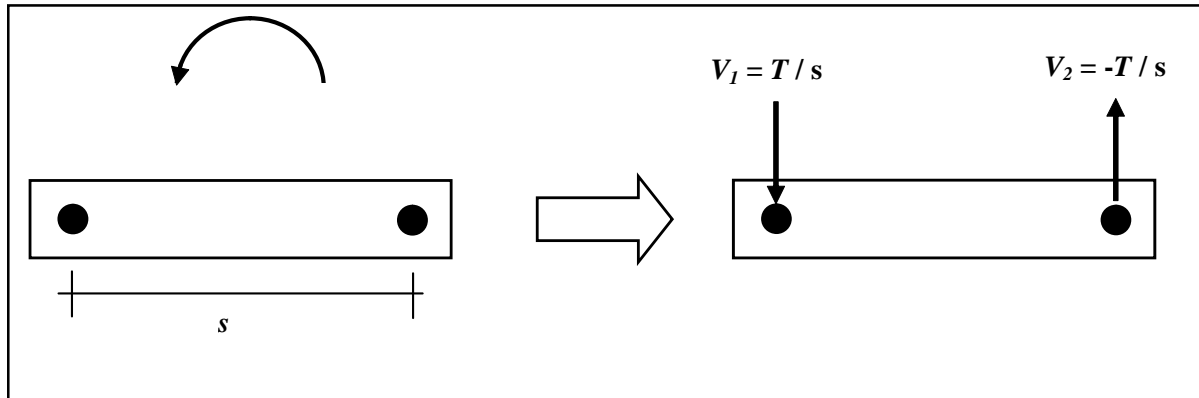

Figure 5.5a Group of anchors loaded by a torsion moment; shear loads acting on the individual anchors of the group alter their directions

In cases where the horizontal or vertical components of the shear loads on the anchors alter their direction within a group the verification of pry-out failure for the entire group is substituted by the verification of pry-out failure for the most unfavourable anchor of the group.

When calculating the resistance of the most unfavourable anchor the influences of both, edge distances as well as anchor spacing should be considered. Examples for the calculation of $A_{c,N}$ are given in Fig. 5.5b.

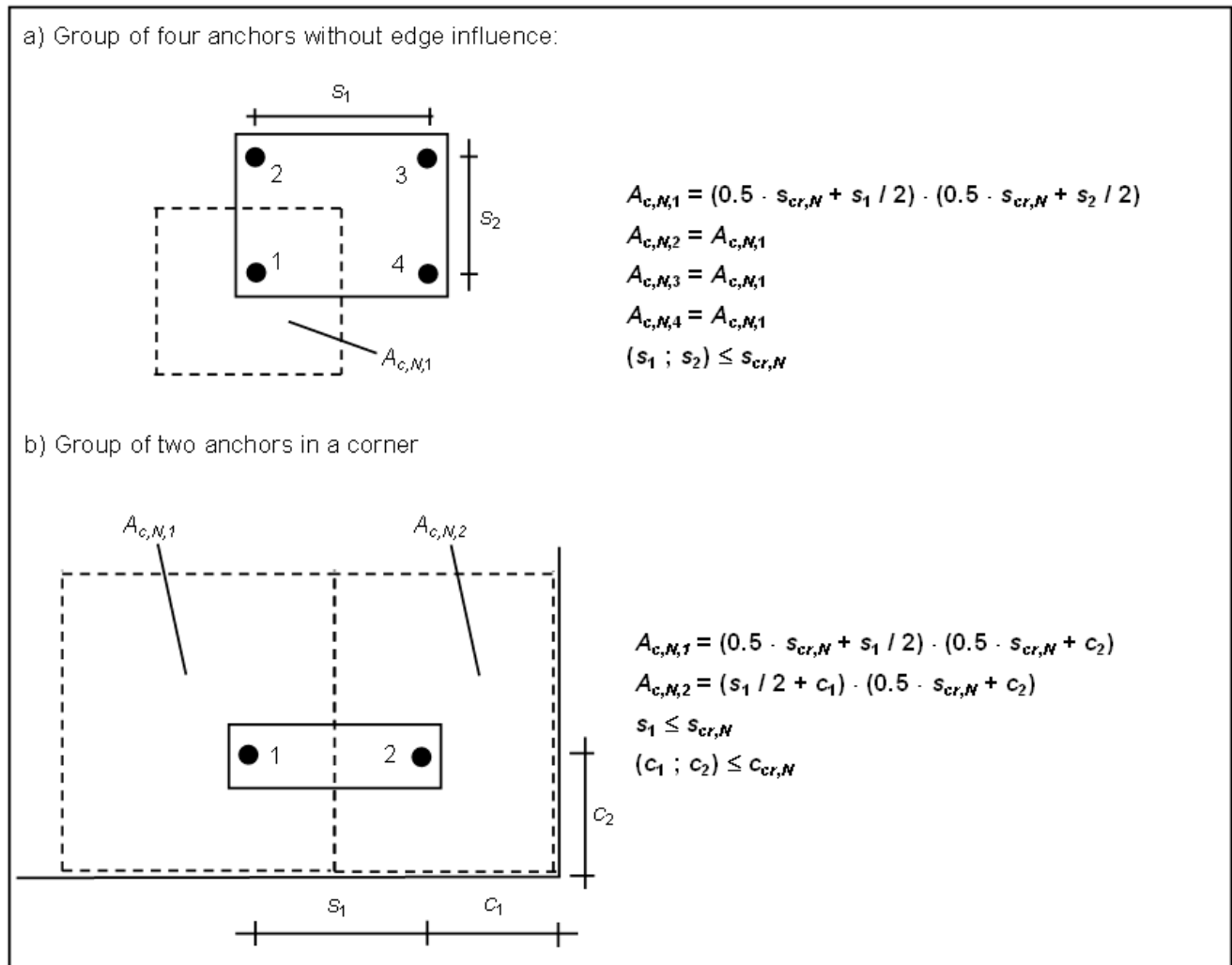

Figure 5.5b Examples for the calculation of the area $A_{c,N}$ of the idealised concrete cones

5.2.3.4 Concrete edge failure

Concrete edge failure need not to be verified for groups with not more than 4 anchors when the edge distance in all directions is $c > 10 h_{ef}$ and $c > 60 d$.

The characteristic resistance for an anchor or an anchor group in the case of concrete edge failure corresponds to:

$$V_{Rk,c} = V_{Rk,c}^0 \cdot \frac{A_{c,V}}{A_{c,V}^0} \cdot \psi_{s,V} \cdot \psi_{h,V} \cdot \psi_{\alpha,V} \cdot \psi_{ec,V} \cdot \psi_{re,V} \quad [N] \quad (5.8)$$

The different factors of Equation (5.8) for anchors according to current experience are given below:

a) The initial value of the characteristic resistance of an anchor placed in cracked or non-cracked concrete and loaded perpendicular to the edge corresponds to:

$$V_{Rk,c}^0 = k_1 \cdot d^\alpha \cdot h_{ef}^\beta \cdot \sqrt{f_{ck,cube}} \cdot c_1^{1.5} \quad [N] \quad (5.8a)$$

d, h_{ef}, c_1 [mm]; $f_{ck,cube}$ [N/mm²]

with

$k_1 = 1.7$ for applications in cracked concrete

$k_1 = 2.4$ for applications in non-cracked concrete

$$\alpha = 0.1 \cdot \left(\frac{h_{ef}}{c_1} \right)^{0.5} \quad (5.8b)$$

$$\beta = 0.1 \cdot \left(\frac{d}{c_1} \right)^{0.2} \quad (5.8c)$$

b) The geometrical effect of spacing as well as of further edge distances and the effect of thickness of the concrete member on the characteristic load is taken into account by the ratio $A_{c,V} / A_{c,V}^0$.

where:

$A_{c,V}^0$ = area of concrete cone of an individual anchor at the lateral concrete surface not affected by edges parallel to the assumed loading direction, member thickness or adjacent anchors, assuming the shape of the fracture area as a half pyramid with a height equal to c_1 and a base-length of $1.5 c_1$ and $3 c_1$ (Figure 5.6).

$$= 4,5 c_1^2 \quad (5.8d)$$

$A_{c,V}$ = actual area of concrete cone of anchorage at the lateral concrete surface. It is limited by the overlapping concrete cones of adjoining anchors ($s \leq 3 c_1$) as well as by edges parallel to the assumed loading direction ($c_2 \leq 1.5 c_1$) and by member thickness ($h \leq 1.5 c_1$). Examples for calculation of $A_{c,V}$ are given in Figure 5.7.

For the calculation of $A_{c,V}^0$ and $A_{c,V}$ it is assumed that the shear loads are applied perpendicular to the edge of the concrete member.

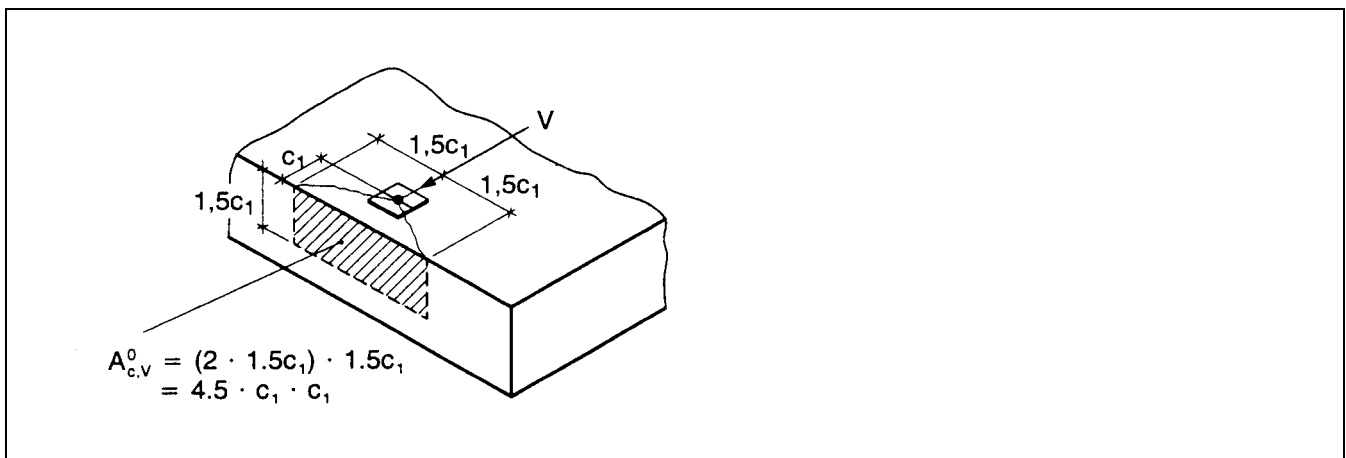
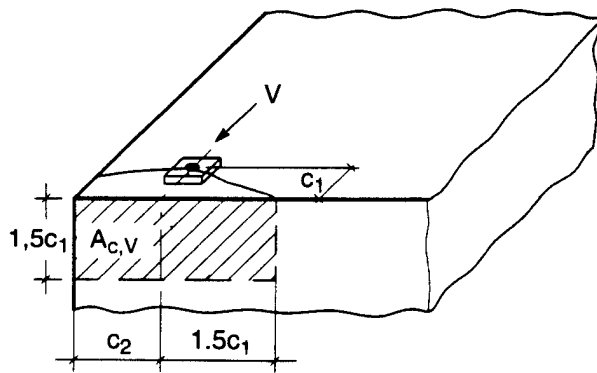

Figure 5.6 Idealized concrete cone and area $A_{c,V}^0$ of concrete cone for a single anchor



$$A_{c,v} = 1.5c_1 (1.5c_1 + c_2)$$

$$h > 1.5c_1$$

$$c_2 \leq 1.5c_1$$

a) single anchor at a corner

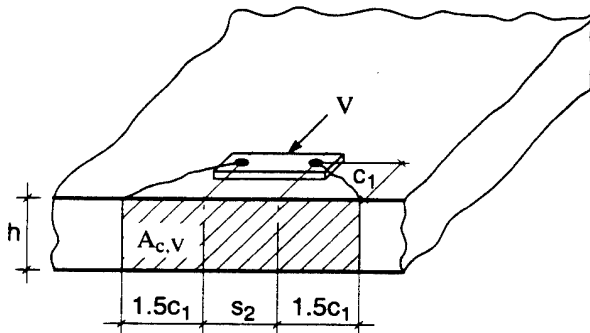

$$A_{c,v} = (2 \cdot 1.5c_1 + s_2) \cdot h$$

$$h \leq 1.5c_1$$

$$s_2 \leq 3c_1$$

b) group of anchors at an edge in a thin concrete member

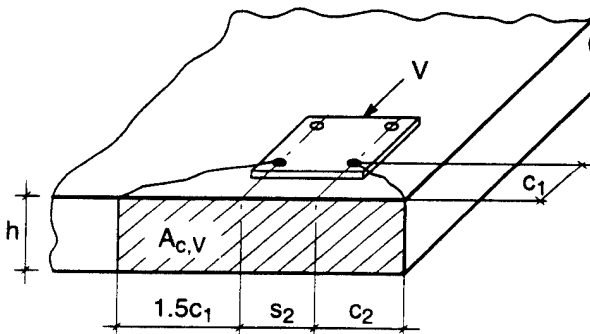

$$A_{c,v} = (1.5c_1 + s_2 + c_2) \cdot h$$

$$h \leq 1.5c_1$$

$$s_2 \leq 3c_1$$

$$c_2 \leq 1.5c_1$$

c) group of anchors at a corner in a thin concrete member

Figure 5.7 Examples of actual areas of the idealized concrete cones for different anchor arrangements under shear loading

- c) The factor $\psi_{s,V}$ takes account of the disturbance of the distribution of stresses in the concrete due to further edges of the concrete member on the shear resistance. For anchorages with two edges parallel to the assumed direction of loading (e.g. in a narrow concrete member) the smaller edge distance shall be inserted in Equation (5.8e).

$$\psi_{s,V} = 0.7 + 0.3 \cdot \frac{c_2}{1.5 c_1} \leq 1 \quad (5.8e)$$

- d) The factor $\psi_{h,V}$ takes account of the fact that the shear resistance does not decrease proportionally to the member thickness as assumed by the ratio $A_{c,V}/A_{c,V}^0$.

$$\psi_{h,V} = \left(\frac{1.5c_1}{h} \right)^{1/2} \geq 1 \quad (5.8f)$$

- e) The factor ψ_{α_V} takes account of the angle α_V between the load applied, V_{Sd} , and the direction perpendicular to the free edge of the concrete member ($\alpha_V \leq 90^\circ$, see Figure 4.7c).

$$\psi_{\alpha,V} = \frac{1}{\sqrt{(\cos \alpha_V)^2 + \left(\frac{\sin \alpha_V}{2.5} \right)^2}} \geq 1.0 \quad (5.8g)$$

The maximum value α_V to be inserted in equation (5.8g) is limited to 90° .

In case of $\alpha_V > 90^\circ$ it is assumed that only the component of the shear load parallel to the edge is acting on the anchor. The component acting away from the edge may be neglected for the proof of concrete edge failure. Examples of anchor groups loaded by M_{Td} , V_{Sd} or both are given in Fig. 5.8 and Fig.5.9.

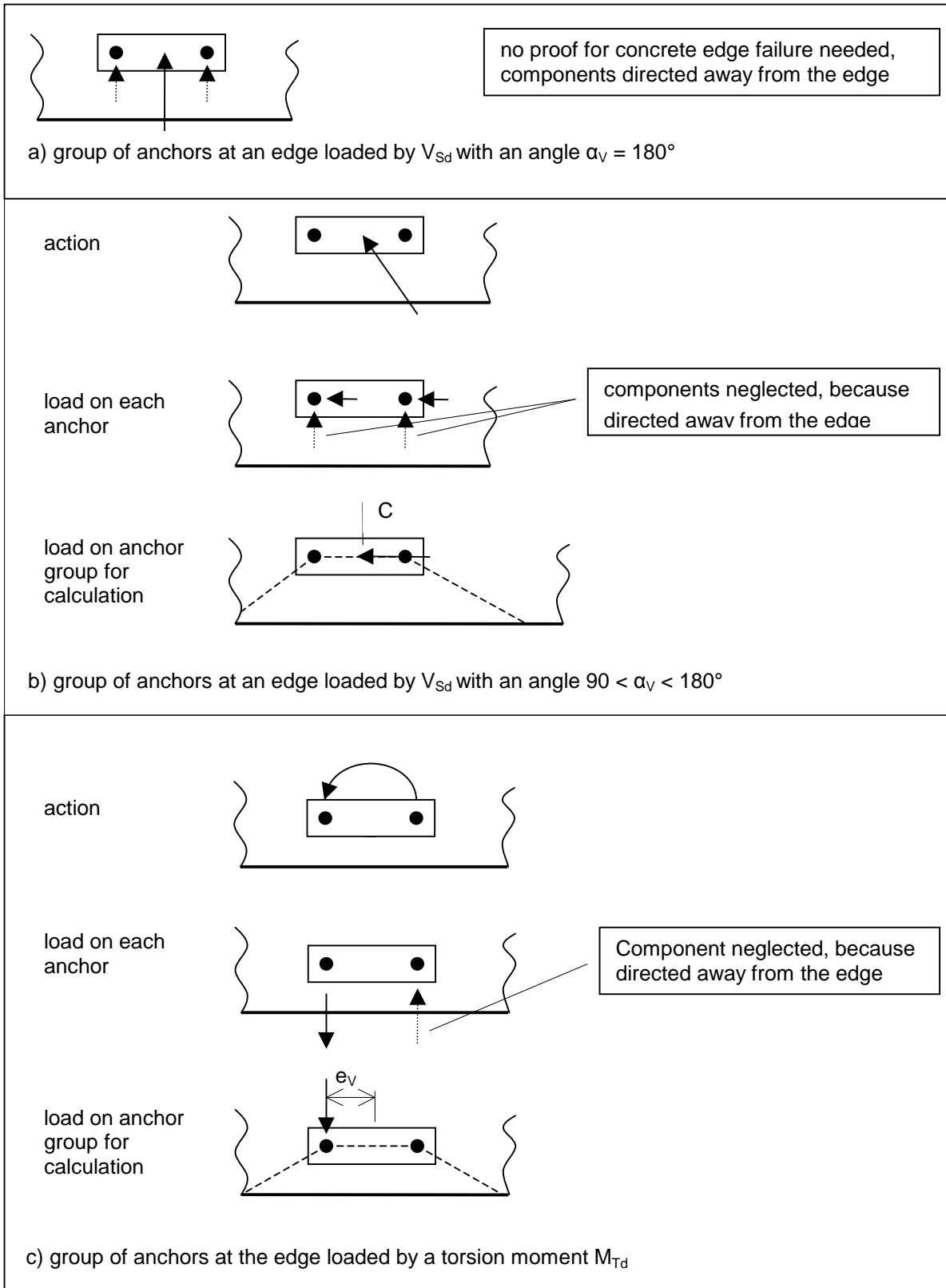

Figure 5.8 Examples of anchor groups at the edge loaded by a shear force or a torsion moment

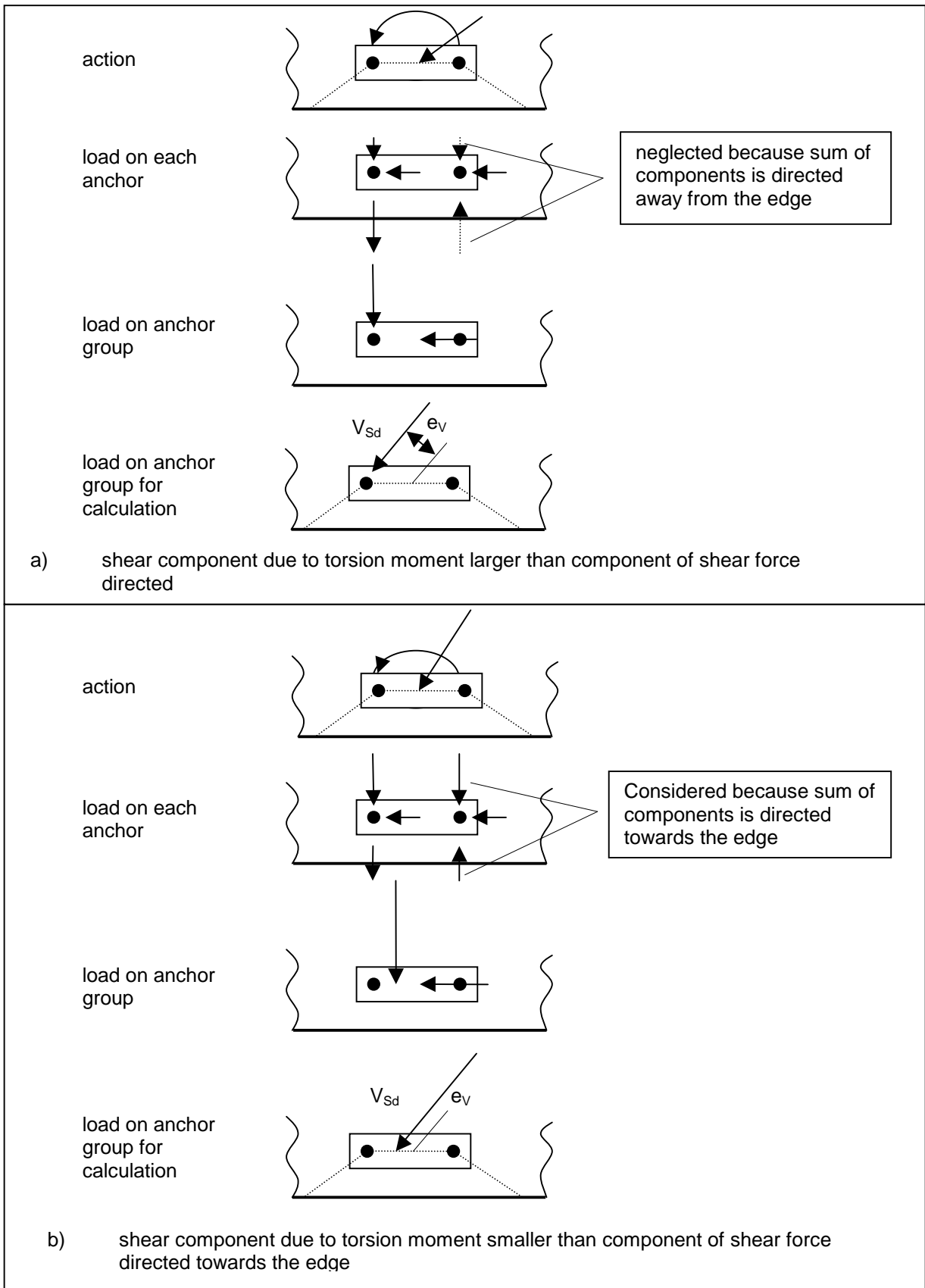

Figure 5.9 Examples of anchors groups at the edge loaded by a shear force and a torsion moment

- f) The factor $\psi_{ec,V}$ takes account of a group effect when different shear loads are acting on the individual anchors of a group.

$$\psi_{ec,V} = \frac{1}{1 + 2e_V / (3c_1)} \leq 1 \quad (5.8h)$$

e_V = eccentricity of the resulting shear load acting on the anchors (see 4.2.2).

- g) The factor $\psi_{re,V}$ takes account of the effect of the type of reinforcement used in cracked concrete.

$\psi_{re,V} = 1.0$ anchorage in non-cracked concrete and anchorage in cracked concrete without edge reinforcement

$\psi_{re,V} = 1.2$ anchorage in cracked concrete with straight edge reinforcement ($\geq \text{Ø}12$ mm)

$\psi_{re,V} = 1.4$ anchorage in cracked concrete with edge reinforcement and closely spaced stirrups ($a \leq 100$ mm)

- h) For anchorages placed at a corner, the resistances for both edges shall be calculated and the smallest value is decisive.

- i) Special cases

For anchorages in a narrow, thin member with $c_{2,max} < 1.5 c_1$ ($c_{2,max}$ = greatest of the two edge distances parallel to the direction of loading) and $h < 1.5 c_1$ (see Figure 5.10) the calculation according to Equation (5.8) leads to results which are on the safe side.

More precise results are achieved if in Equations (5.8a) to (5.8f) as well as in the determination of the areas $A_{c,V}^0$ and $A_{c,V}$ according to Figures 5.6 and 5.7 the edge distance c_1 is replaced by the value of c'_1 . c'_1 being the greatest of the values $c_{2,max}/1.5$ and $h/1.5$ or $s_{2,max}/3$ in case of anchor groups

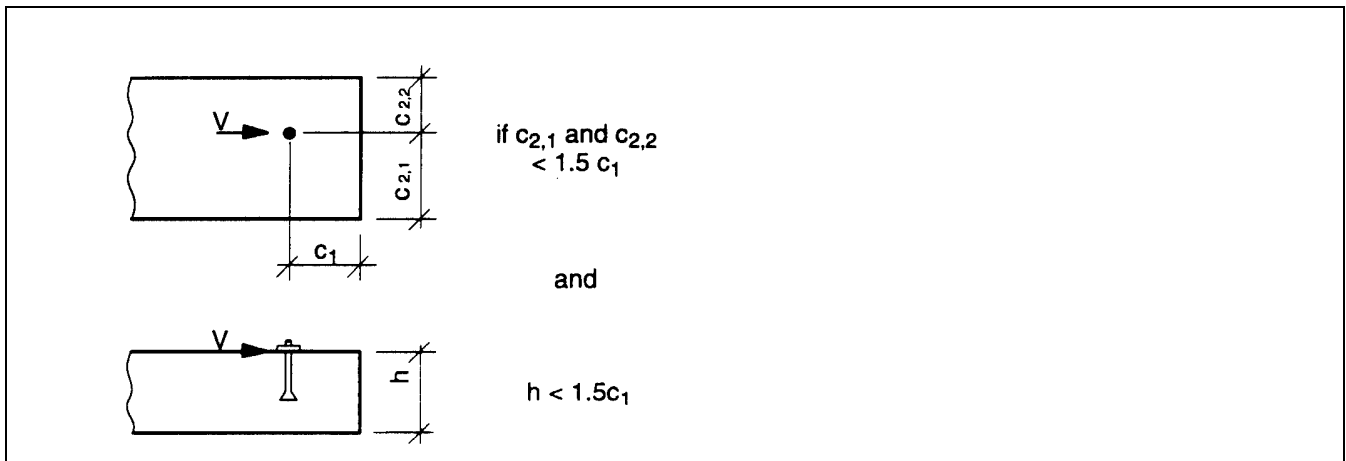

Figure 5.10 Example of an anchorage in a thin, narrow member where the value c'_1 may be used

5.2.4 Resistance to combined tension and shear loads

For combined tension and shear loads the following Equations (see Figure 5.11) shall be satisfied:

$$\beta_N \leq 1 \quad (5.9a)$$

$$\beta_V \leq 1 \quad (5.9b)$$

$$\beta_N + \beta_V \leq 1.2 \quad (5.9c)$$

where

β_N (β_V) ratio between design action and design resistance for tension (shear) loading.

In Equation (5.9) the largest value of β_N and β_V for the different failure modes shall be taken (see 5.2.2.1 and 5.2.3.1).

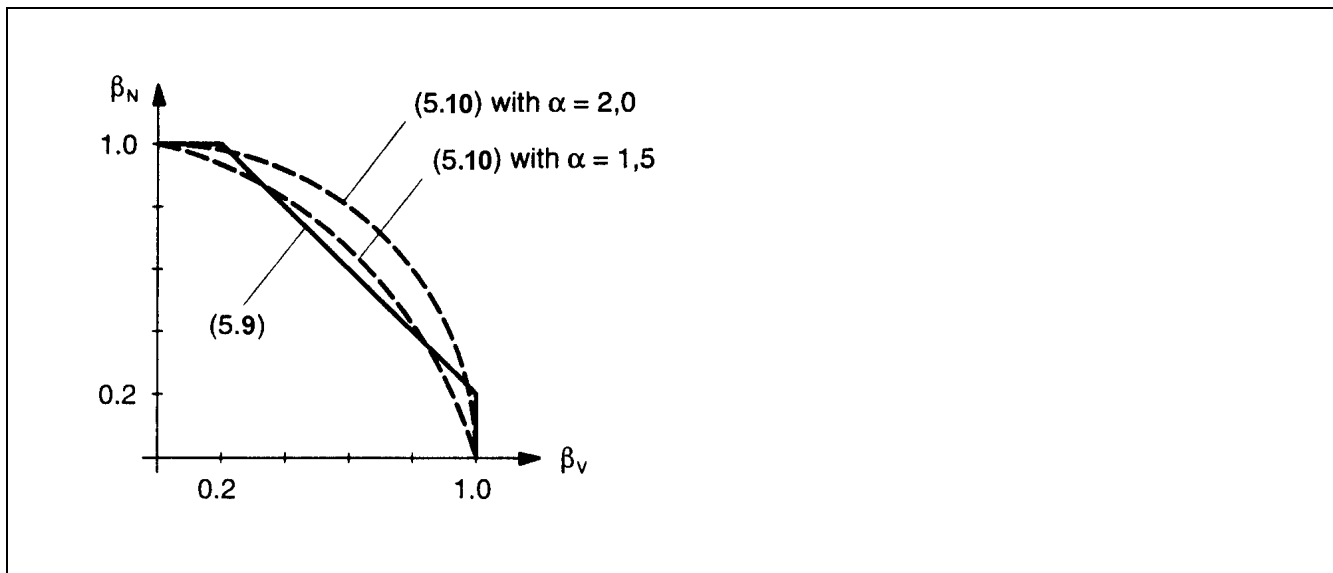

Figure 5.11 Interaction diagram for combined tension and shear loads

In general, Equations (5.9a) to (5.9c) yield conservative results. More accurate results are obtained by Equation (5.10)

$$(\beta_N)^\alpha + (\beta_V)^\alpha \leq 1 \quad (5.10)$$

with:

- β_N, β_V see Equations (5.9)
- $\alpha = 2.0$ if N_{Rd} and V_{Rd} are governed by steel failure
- $\alpha = 1.5$ for all other failure modes

6 Serviceability limit state

6.1 Displacements

The characteristic displacement of the anchor under defined tension and shear loads shall be taken from the ETA. It may be assumed that the displacements are a linear function of the applied load. In case of a combined tension and shear load, the displacements for the tension and shear component of the resultant load should be geometrically added.

In case of shear loads the influence of the hole clearance in the fixture on the expected displacement of the whole anchorage shall be taken into account.

6.2 Shear load with changing sign

If the shear loads acting on the anchor change their sign several times, appropriate measures shall be taken to avoid a fatigue failure of the anchor steel (e.g. the shear load should be transferred by friction between the fixture and the concrete (e.g. due to a sufficiently high permanent prestressing force)).

Shear loads with changing sign can occur due to temperature variations in the fastened member (e.g. facade elements). Therefore, either these members are anchored such that no significant shear loads due to the restraint of deformations imposed to the fastened element will occur in the anchor or in shear loading with lever arm (stand-off installation) the bending stresses in the most stressed anchor $\Delta\sigma = \max\sigma - \min\sigma$ in the serviceability limit state caused by temperature variations should be limited to 100 N/mm^2 .

7 Additional proofs for ensuring the characteristic resistance of concrete member

7.1 General

The proof of the local transmission of the anchor loads into the concrete member is delivered by using the design methods described in this document.

The transmission of the anchor loads to the supports of the concrete member shall be shown for the ultimate limit state and the serviceability limit state; for this purpose, the normal verifications shall be carried out under due consideration of the actions introduced by the anchors. For these verifications the additional provisions given in 7.2 and 7.3 should be taken into account.

If the edge distance of an anchor is smaller than the characteristic edge distance $c_{cr,N}$, then a longitudinal reinforcement of at least $\varnothing 6$ shall be provided at the edge of the member in the area of the anchorage depth.

In case of slabs and beams made out of prefabricated units and added cast-in-place concrete, anchor loads may be transmitted into the prefabricated concrete only if the precast concrete is connected with the cast-in-place concrete by a shear reinforcement. If this shear reinforcement between precast and cast-in-place concrete is not present, the anchors should be embedded with h_{ef} in the added concrete. Otherwise only the loads of suspended ceilings or similar constructions with a load up to 1.0 kN/m^2 may be anchored in the precast concrete.

7.2 Shear resistance of concrete member

In general, the shear forces $V_{Sd,a}$ caused by anchor loads should not exceed the value

$$V_{Sd,a} = 0.4 V_{Rd1} \quad (7.1)$$

with:

$$V_{Rd1} = \text{shear resistance according Eurocode No. 2 [1]}$$

When calculating $V_{Sd,a}$ the anchor loads shall be assumed as point loads with a width of load application $t_1 = s_{t1} + 2 h_{ef}$ and $t_2 = s_{t2} + 2 h_{ef}$, with s_{t1} (s_{t2}) spacing between the outer anchors of a group in direction 1 (2). The active width over which the shear force is transmitted should be calculated according to the theory of elasticity.

Equation (7.1) may be neglected, if one of the following conditions is met

a) The shear force V_{Sd} at the support caused by the design actions including the anchor loads is

$$V_{Sd} \leq 0.8 V_{Rd1} \quad (7.2)$$

b) Under the characteristic actions, the resultant tension force, N_{Sk} , of the tensioned fasteners is $N_{Sk} \leq 30 \text{ kN}$ and the spacing, a , between the outermost anchors of adjacent groups or between the outer anchors of a group and individual anchors satisfies Equation (7.3)

$$a \geq 200 \cdot \sqrt{N_{Sk}} \quad a \text{ [mm]; } N_{Sk} \text{ [kN]} \quad (7.3)$$

c) The anchor loads are taken up by a hanger reinforcement, which encloses the tension reinforcement and is anchored at the opposite side of the concrete member. Its distance from an individual anchor or the outermost anchors of a group should be smaller than h_{ef}

If under the characteristic actions, the resultant tension force, N_{Sk} , of the tensioned fasteners is $N_{Sk} \geq 60 \text{ kN}$, then either the embedment depth of the anchors should be $h_{ef} \geq 0,8 h$ or a hanger reinforcement according to paragraph c) above should be provided.

The necessary checks for ensuring the required shear resistance of the concrete member are summarized in Table 7.1.

Table 7.1 Necessary checks for ensuring the required shear resistance of concrete member

Calculated value of shear force of the concrete member under due consideration of the anchor loads	Spacing between single anchors and groups of anchors	N_{Sk} [kN]	Proof of calculated shear force resulting from anchor loads
$V_{Sd} \leq 0.8 \cdot V_{Rd1}$	$a \geq s_{cr,N}$	≤ 60	not required
$V_{Sd} > 0.8 \cdot V_{Rd1}$	$a \geq s_{cr,N}$ and $a \geq 200 \cdot \sqrt{N_{Sk}}$	≤ 30	not required
	$a \geq s_{cr,N}$	≤ 60	required: $V_{Sd,a} \leq 0.4 \cdot V_{Rd1}$ or hanger reinforcement or $h_{ef} \geq 0.8 h$
		> 60	not required, but hanger reinforcement or $h_{ef} \geq 0.8 h$

7.3 Resistance to splitting forces

In general, the splitting forces caused by anchors should be taken into account in the design of the concrete member. This may be neglected if one of the following conditions is met:

- The load transfer area is in the compression zone of the concrete member.
- The tension component N_{Sk} of the characteristic loads acting on the anchorage (single anchor or group of anchors) is smaller than 10 kN.
- The tension component N_{Sk} is not greater than 30 kN. In addition, for fastenings in slabs and walls a concentrated reinforcement in both directions is present in the region of the anchorage. The area of the transverse reinforcement should be at least 60 % of the longitudinal reinforcement required for the actions due to anchor loads.

If the characteristic tension load acting on the anchorage is $N_{Sk} \geq 30$ kN and the anchors are located in the tension zone of the concrete member the splitting forces shall be taken up by reinforcement. As a first indication for anchors according to current experience the ratio between splitting force $F_{Sp,k}$ and the characteristic tension load N_{Sk} may be taken as

$$F_{Sp,k} = 0.5 N_{Sk} \quad \text{for bonded anchors.}$$